

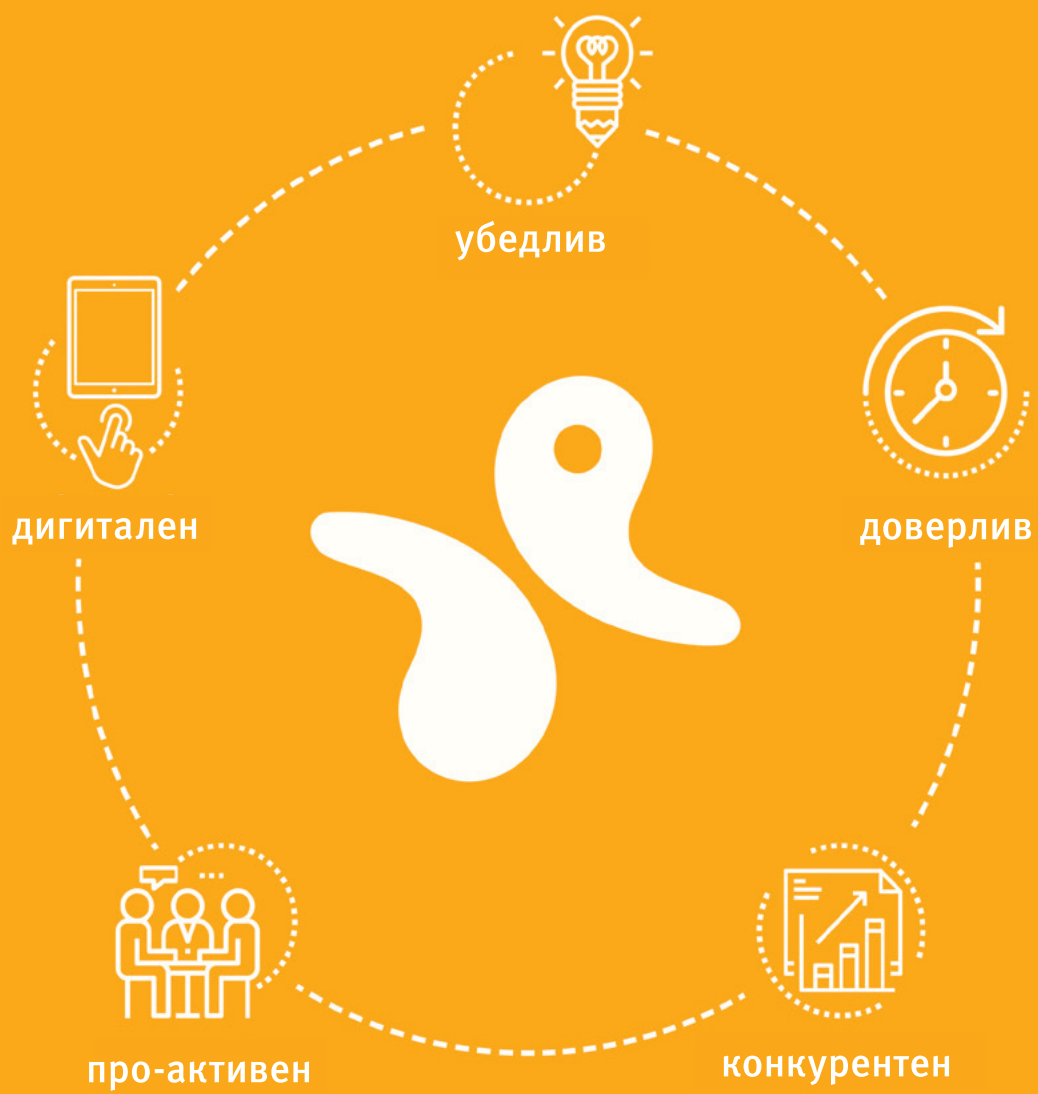

каталог 2021

ПАМЕТНИ
решенија за
ОКОВ ЗА МЕБЕЛ

emusa 



ПАМЕТНИ РЕШЕНИЈА ЗА ОКОВ ЗА МЕБЕЛ

Со над 35 години искуство Emuca Group дизајнира, произведува и продава широк спектар на производи за мебел, столарија и DIY (направи сам) оков.

Нашите комерцијални центри во Валенсија (Шпанија), Падова (Италија), Челмсфорд (Обединетото Кралство), Нант (Франција) и Лисабон (Португалија) ни овозможуваат да останеме во директен контакт со најновите трендови во секторот за мебел и нашите дизајнерски тимови се посветени на одразување на овие трендови во нашите производи.

За да се осигураме дека нашите операции и решенија се ефикасни, имаме фабрика во Шпанија која нуди комплетни решенија во алуминиум.

Меѓународно присуство

Со над 37 години присутност на пазарот, сакаме да бидеме блиски со нашите клиенти и затоа имаме различни подружници низ цела Европа. Ние извезуваме во над 50 земји и имаме обемна, целосно обучена продажна мрежа низ цела Европа, од кои сите се свесни за барањата поставени до нас на различните пазари.

Нашето седиште во Падова, Италија, значи дека ние сме директно во контакт со најновите дизајнерски трендови на мебел во Италија, преку кој ги пренесуваме на дизајнот на сопствените производи. Нашите логистички капацитети во Падова се нашата најголема стратешка точка поради нивната локација во северниот дел на Италија, што ја олеснува дистрибуцијата на нашите производи низ цела Европа.





ШАРКИ И ДОДАТОЦИ	5
ВОДИЛКИ И ФИОКИ	22
НОГАРКИ, ТРКАЛЦА	35
И КАНЦЕЛАРИСКИ ОКОВ	35
ОКОВ ЗА СПОЈУВАЊЕ	47
СИСТЕМИ ЗА ЛИЗГАЧКИ ВРАТИ И ДОДАТОЦИ	60
ЗАВРШНИ ЛАЈСНИ И ЦОКЛИ	92
ГОЛА ПРОФИЛИ	96
КУЈНСКИ СИСТЕМИ.....	100
РАЧКИ	113
ОСВЕТЛУВАЊЕ.....	117

emuca 



Шарки и Додатоци

X91 ШАРКИ СО Ø35mm

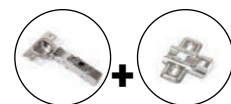

X91 шарка права 100° клип со вградено меко затворање



- со Ø 35mm
- монтажа и демонтажа на вратата без алат
- за дебелина на врата од 14-24mm
- 3D подесување (со соодветна подлошка)
- Дистанца од работ на вратата до отворот за шарката D=3-7mm
- Длабинско подесување преку штраф со навој
- Со пружина за отворање и затворање

X91 Подлошка со штрафење



Н
7863 | omm | 9 ден.

X91 Подлошка со 3D штелување



Н
7875 | omm | 19 ден.

7910 | 75 ден.

X91 шарка полуколенаста 100° клип со вградено меко затворање



- со Ø 35mm
- монтажа и демонтажа на вратата без алат
- за дебелина на врата од 14-24mm
- 3D подесување (со соодветна подлошка)
- Дистанца од работ на вратата до отворот за шарката D=3-7mm
- Длабинско подесување преку штраф со навој
- Со пружина за отворање и затворање

X91 Подлошка со штрафење



Н
7863 | omm | 9 ден.

X91 Подлошка со 3D штелување



Н
7875 | omm | 19 ден.

7891 | 77 ден.

X91 шарка коленаста 100° клип со вградено меко затворање



- Со Ø 35mm
- Монтажа и демонтажа на вратата без алат
- За дебелина на врата од 14-24mm
- 3D подесување (со соодветна подлошка)
- Дистанца од работ на вратата до отворот за шарката D=3-7mm
- Длабинско подесување преку штраф со навој
- Со пружина за отворање и затворање

X91 Подлошка со штрафење



Н
7913 | 2mm | 9 ден.

X91 Подлошка со 3D штелување



Н
7393 | 2mm | 20 ден.

7394 | 77 ден.

X91 ШАРКИ СО Ø35mm



X91 шарка клип 45° со вградено меко затворање



- со \varnothing 35mm
- монтажа и демонтажа на вратата без алат
- за дебелина на врата од 14-24mm
- 3D подесување (со соодветна подлошка)
- Дистанца од работ на вратата до отворот за шарката D=3-7mm
- Длабинско подесување преку штраф со навој
- Вградено меко затворање

X91 Подлошка со штрафење



H
7863 | 0mm | 9 ден.

X91 Подлошка со 3D штелување



H
7875 | 0mm | 19 ден.

91828 | 155 ден.

X91 шарка клип 90° со вградено меко затворање



- со \varnothing 35mm
- монтажа и демонтажа на вратата без алат
- за дебелина на врата од 14-24mm
- 3D подесување (со соодветна подлошка)
- Дистанца од работ на вратата до отворот за шарката D=3-7mm
- Длабинско подесување преку штраф со навој
- Вградено меко затворање

X91 Подлошка со штрафење



H
7913 | 2mm | 9 ден.

X91 Подлошка со 3D штелување



H
7393 | 2mm | 20 ден.

7917 | 113 ден.

X91 шарка клип 165° со вградено меко затворање



- Со \varnothing 35mm
- Монтажа и демонтажа на вратата без алат
- За дебелина на врата од 14-26mm
- 3D подесување (со соодветна подлошка)
- Дистанца од работ на вратата до отворот за шарката D=3-7mm
- Длабинско подесување преку штраф со навој
- Вградено меко затворање

X91 Подлошка со штрафење



H
7913 | 2mm | 9 ден.

X91 Подлошка со 3D штелување



H
7393 | 2mm | 20 ден.

7866 | 186 ден.

X91 Подлошка со штрафење



	Н	
7863	0mm	9 ден.
7913	2mm	9 ден.
7916	4mm	10 ден.

X91 Подлошка со 3D штелување



	Н	
7875	0mm	19 ден.
7393	2mm	20 ден.

X91 Подлошка со типла Ø5mm



	Н	
90324	0mm	12 ден.

X91N ШАРКИ СО Ø35mm

X91N
by emuca



X91N шарка права 100° клип



- Со Ø 35mm
- Монтажа и демонтажа на вратата без алат
- За дебелина на врата од 14-24mm
- 3D подесување (со соодветна подлошка)
- Дистанца од работ на вратата до отворот за шарката D=3-7mm
- Длабинско подесување преку штраф со навој
- Со самозатворање

X91 Подлошка со штрафење



H
7863 | omm | 9 ден.

X91 Подлошка со 3D штелување



H
7875 | omm | 19 ден.

7918 | 46 ден.

X91N шарка полуколенасто 100° клип



- Со Ø 35mm
- Монтажа и демонтажа на вратата без алат
- За дебелина на врата од 14-24mm
- 3D подесување (со соодветна подлошка)
- Дистанца од работ на вратата до отворот за шарката D=3-7mm
- Длабинско подесување преку штраф со навој
- Со самозатворање

X91 Подлошка со штрафење



H
7863 | omm | 9 ден.

X91 Подлошка со 3D штелување



H
7875 | omm | 19 ден.

7905 | 48 ден.

X91N шарка коленаста 100° клип



- Со Ø 35mm
- Монтажа и демонтажа на вратата без алат
- За дебелина на врата од 14-24mm
- 3D подесување (со соодветна подлошка)
- Дистанца од работ на вратата до отворот за шарката D=3-7mm
- Длабинско подесување преку штраф со навој
- Со самозатворање

X91 Подлошка со штрафење



H
7913 | 2mm | 9 ден.

X91 Подлошка со 3D штелување



H
7393 | 2mm | 20 ден.

7909 | 48 ден.

X91N ШАРКИ СО Ø35mm

X91N

by emuca

X91N шарка 90° клип



- Со Ø 35mm
- Монтажа и демонтажа на вратата без алат
- За дебелина на врата од 14-24mm
- 3D подесување (со соодветна подлошка)
- Дистанца од работ на вратата до отворот за шарката D=3-7mm
- Длабинско подесување преку штраф со навој

X91 Подлошка со штрафење



H
7863 | omm | 9 ден.

X91 Подлошка со 3D штелување



H
7875 | omm | 19 ден.

90938 | 71 ден.

X91N шарка 135° клип



- Со Ø 35mm
- Монтажа и демонтажа на вратата без алат
- За дебелина на врата од 14-24mm
- 3D подесување (со соодветна подлошка)
- Дистанца од работ на вратата до отворот за шарката D=3-7mm
- Длабинско подесување преку штраф со навој

X91 Подлошка со штрафење



H
7863 | omm | 9 ден.

X91 Подлошка со 3D штелување



H
7875 | omm | 19 ден.

91827 | 114 ден.

X91N шарка 165° клип



- Со Ø 35mm
- Монтажа и демонтажа на вратата без алат
- За дебелина на врата од 14-26mm
- 3D подесување (со соодветна подлошка)
- Дистанца од работ на вратата до отворот за шарката D=3-7mm
- Длабинско подесување преку штраф со навој

X91 Подлошка со штрафење



H
7863 | omm | 9 ден.

X91 Подлошка со 3D штелување



H
7875 | omm | 19 ден.

90939 | 156 ден.

X91N шарка 100° клип права без пружина



- Со Ø 35mm
- Монтажа и демонтажа на вратата без алат
- За дебелина на врата од 14-24mm
- 3D подесување (со соодветна подлошка)
- Дистанца од работ на вратата до отворот за шарката D=3~7mm
- Длабинско подесување преку штраф со навој

X91 Подлошка со штрафење



H

7863 | omm | 9 ден.

X91 Подлошка со 3D штелување



H

7875 | omm | 19 ден.

91836 | 59 ден.

X91/C90 капаче за шарка



90160 | 4 ден.

C95 ШАРКИ СО Ø35mm

C95

by emusa

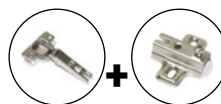

C95 шарка права 110° со откlopen федер



- Со Ø 35mm
- За дебелина на врата од 14-23mm
- Со 2Д подесување вертикално 0-4mm и хоризонтално од 0-5mm
- Дистанца од работ на вратата до отворот за шарката D=3-7mm
- Отворање со откlopen федер

C95 Подлошка со штрафење



H

7904 | 0mm | 9 ден.

7881 | 31 ден.

C95 шарка полуколенаста 110° со откlopen федер



- Со Ø 35mm
- За дебелина на врата од 14-23mm
- Со 2Д подесување вертикално 0-4mm и хоризонтално од 0-5mm
- Дистанца од работ на вратата до отворот за шарката D=3-7mm
- Отворање со откlopen федер

C95 Подлошка со штрафење



H

7904 | 0mm | 9 ден.

7870 | 33 ден.

C95 шарка коленаста 110° со откlopen федер



- Со Ø 35mm
- За дебелина на врата од 14-23mm
- Со 2Д подесување вертикално 0-4mm и хоризонтално од 0-5mm
- Дистанца од работ на вратата до отворот за шарката D=3-7mm
- Отворање со откlopen федер

C95 Подлошка со штрафење



H

7906 | 2mm | 9 ден.

7902 | 33 ден.

C95 ШАРКИ СО Ø35mm

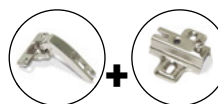

C95 шарка 90° слајд



- Со Ø 35mm
- За дебелина на врата од 14-23mm
- Со 2Д подесување вертикално 0-4mm и хоризонтално од 0-5mm
- Дистанца од работ на вратата до отворот за шарката D=3-7mm

C95 Подлошка со штрафење



H

7906 | 2mm | 9 ден.

7873 | 39 ден.

C95 шарка 135° слајд



- Со Ø 35mm
- За дебелина на врата од 14-22mm
- Со 2Д подесување вертикално 0-4mm и хоризонтално од 0-5mm
- Дистанца од работ на вратата до отворот за шарката D=3-7mm

C95 Подлошка со штрафење



H

7906 | 2mm | 9 ден.

7894 | 52 ден.

C95 шарка 165° слајд



- Со Ø 35mm
- За дебелина на врата од 14-26mm
- 3D подесување (со соодветна подлошка)
- Дистанца од работ на вратата до отворот за шарката D=3-8mm

C95 Подлошка со штрафење



H

7906 | 2mm | 9 ден.

7865 | 99 ден.

C95 ШАРКИ СО Ø35mm

C95

by emusa

C95 шарка права



- Со Ø 35mm
- За дебелина на врата од 14-23mm
- Со 2Д подесување вертикално 0-4mm и хоризонтално од 0-5mm
- Дистанца од работ на вратата до отворот за шарката D=3-7mm

C95 Подлошка со штрафење



H

7906 | 2mm | 9 ден.

90309 | без пружина | 46 ден.

90310 | со типла без пружина | 54 ден.

C95 шарка полуколенаста



- Со Ø 35mm
- За дебелина на врата од 14-23mm
- Со 2Д подесување вертикално 0-4mm и хоризонтално од 0-5mm
- Дистанца од работ на вратата до отворот за шарката D=3-7mm

C95 Подлошка со штрафење



H

7906 | 2mm | 9 ден.

90311 | 47 ден.

C95 шарка коленаста



- Со Ø 35mm
- За дебелина на врата од 14-23mm
- Со 2Д подесување вертикално 0-4mm и хоризонтално од 0-5mm
- Дистанца од работ на вратата до отворот за шарката D=3-7mm

C95 Подлошка со штрафење



H

7906 | 2mm | 9 ден.

90312 | 47 ден.

C50 ШАРКИ СО Ø35mm

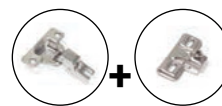
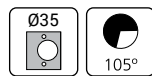

ШАРКИ И ДОДАТОЦИ

Шарка мини C50



- Со Ø 35mm
- За дебелина на врата од 16-23mm
- Со 2Д подесување вертикално 0-4mm и хоризонтално од 0-5mm
- Дистанца од работ на вратата до отворот за шарката D=3-7mm
- Затворање со откlopen федер

C50 Подлошка за шарка



7900 | 11 ден.

7899 | 34 ден.

C95 подлошка за штрафење

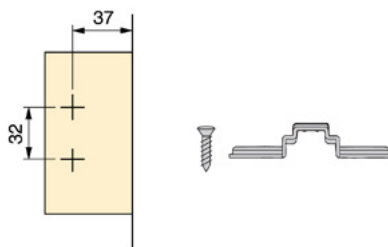

	Н	
7904	0mm	9 ден.
7906	2mm	9 ден.

C95 Ø40 Шарка права



- Со Ø 40mm
- За дебелина на врата од 20-40mm
- 3D подесување (со соодветна подлошка)
- Дистанца од работ на вратата до отворот за шарката D=3-15mm
- Затворање со откlopen федер

C95 Подлошка со штрафење



Н
90029 | -2mm | 10 ден.

90028 | 58 ден.

C95 ШАРКИ CO Ø35mm

C90

by emusa



C90 шарка права без пружина клип



- Со Ø 35mm
- За дебелина на врата од 14-23mm
- Со 3Д подесување
- Дистанца од работ на вратата до отворот за шарката D=3-7mm
- Брза монтажа со клип

90313 | 69 ден.

C90 подлошка за шарка

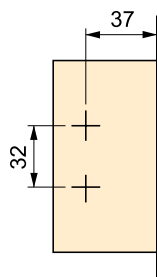

90510 | H omm | 11 ден.





Шарка за бифе 30 x 80мм

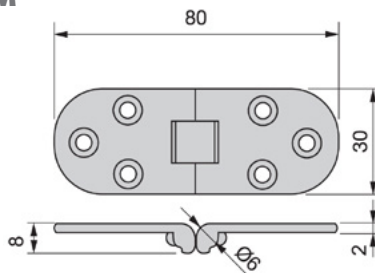

Финиш Н
7907 | месинг | 30x80мм | 354 ден.

Шарка за бифе Ø35mm

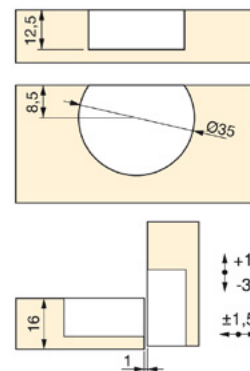
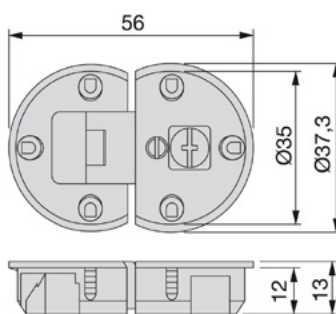

- Со димензија Ø 35mm
- Со подесување +/-3mm

7883 | 119 ден.

Брава за мебел Ø19mm

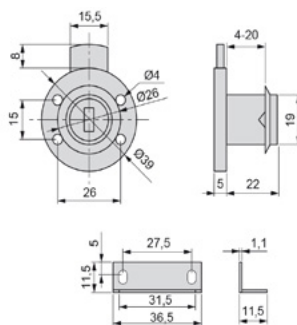

90169 | 148 ден.

Одбојник со кука

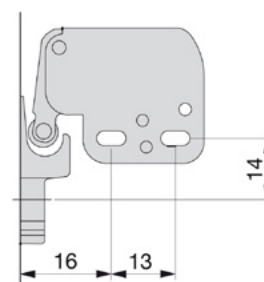
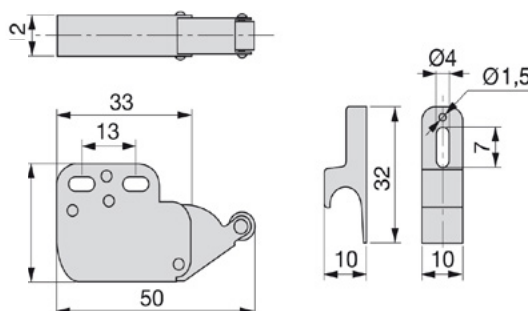

4510 | 104 ден.

REVALOCK клуч



92212 | **474** ден.

REVALOCK сет за заклучување



92211 | **452** ден.

REVALOCK 2x сет за заклучување + 1x клуч



- Клуч за фиоки и врати.
- Магнетот го деактивира клучот и вратата се отвора. Толку едноставно.
- Поради внатрешната монтажа клучот не е видлив и се монтира на врати со дебелина од 13 до 40mm.

92213 | **1.636** ден.



ANKOR GT-B Шарка за бифе

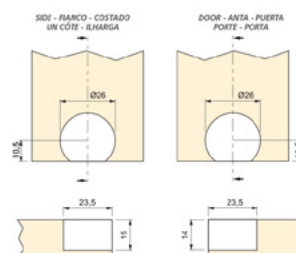
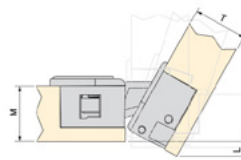
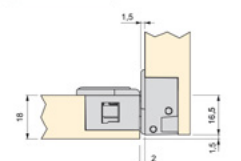
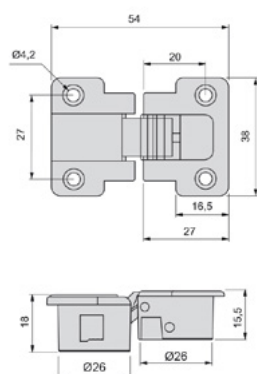

M	L						T					
	18	20	21	24	25	26	18	20	21	24	25	26
18	-	-	-	1,7	3,7	4,7	5,7	-	-	-	-	-
20	-	-	-	1,7	2,7	3,7	-	-	-	-	-	-
22	-	-	-	-	0,7	1,7	-	-	-	-	-	-

- Шарка специјално дизајнирана за врати од бифе со редуцирани димензии. Идеално компатибилна со Miniwinch.
- Вклучено е и капаче изработено од замак кое ги покрива штрафовите за подесување и шарката истовремено давајќи модерен изглед.
- Потребни се отвори за бушење со Ø26 на двете страни
- Со 3Д штелување: латерално, вертикално и фронтално подесување.

91135 | **358** ден.

Маска за ANKOR GT-B



91136 | **Црн** | 35 ден.

91142 | **Бел** | 35 ден.

Push со магнет

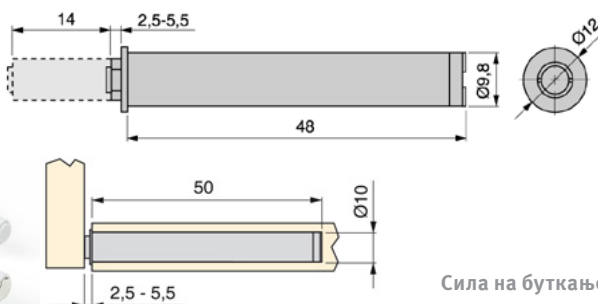
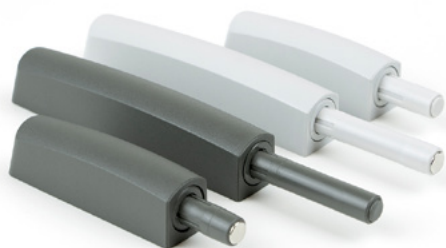

	Сила на буткање	Финиш	
90007	12kg	Сив	160 ден.
90736	12kg	Антрацит	165 ден.
91105	0.7kg	Сив	149 ден.

Push Адаптер за магнет

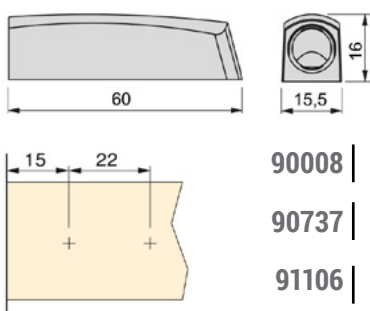

	Водење	Финиш	
90008	кратко в.	Сив	41 ден.
90737	кратко в.	Антрацит	45 ден.
91106	долго в.	Сив	50 ден.

Плочка за ПТО Ø17mm

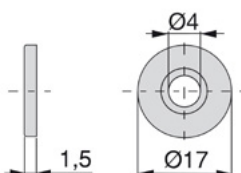

	Материјал	
90161	Цинк	6 ден.

Магнет 3,2кг

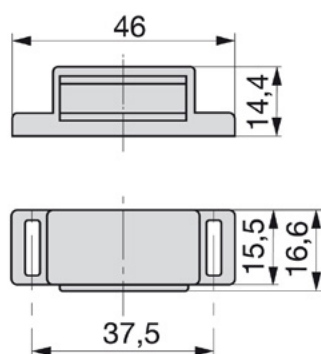

	Финиш	
90023	Бел	23 ден.

Плочка овална за магнет

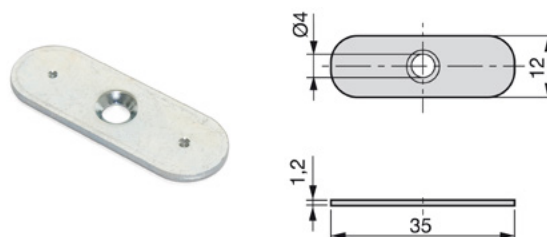

	Димензија	
90168	35x12mm	3 ден.

Miniwinch систем за бифе

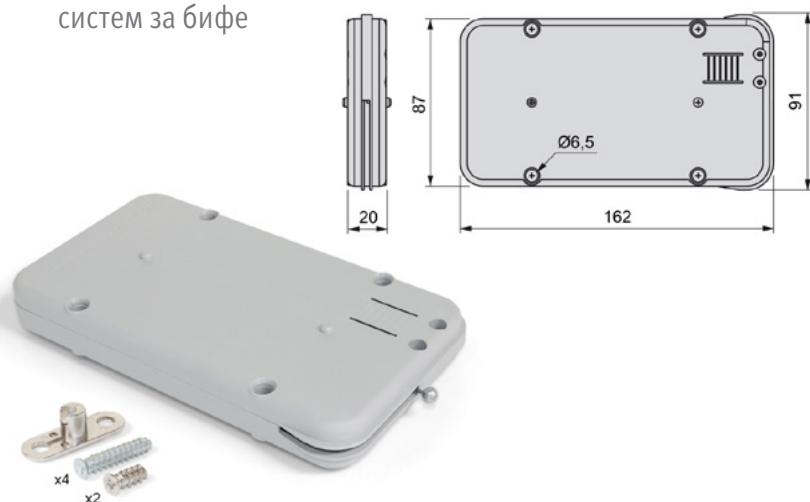

- ▶ Механизам со челичен кабел за врати на преклопување. Со естетиката и иновативноста е функционален механизам. Идеален за домашен мебел.
- ▶ Запазен дизајн со нежни и гемотречни рабови. Со својата големина е неприметлив за окоето. Со своето капаче, финалниот резултат е елегантен.
- ▶ Сопирањето на вратата е регулирано на своја последна позиција.
- ▶ Голем опсег на сопирачка сила, што значи дека е соодведен механизам за врати со висина од 200mm до 480mm и со тежина до 10.6kg
- ▶ При монтирање може да се поставува во вертикална или хоризонтална позиција.
- ▶ Амбидекстрозен механизам, може да се монтира од лева или десна страна на мебелот.
- ▶ Комплетот е составен од потребните штрафови и носачот.

Шифра	Финиш	Носивост	Цена
90741	Сив	4kg	2.120 ден.
90742	Сив	6kg	2.980 ден.



Miniwinch капаче



Шифра	Финиш	Цена
90743	Бел	141 ден.
90748	Црн	141 ден.

Отклопен систем за бифе

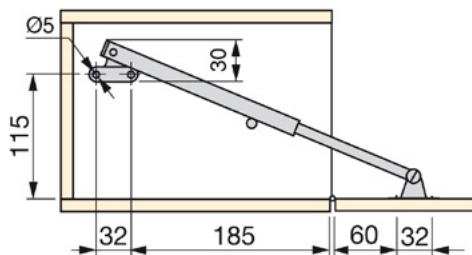

- ▶ Систем за врати на преклопување или една врата
- ▶ Со подесувач се контролира кочењето при отворање.
- ▶ Монтажа од лева или десна страна на елементот.

Шифра	Цена
90751	385 ден.



Водилки и фиоки

Сет водилка со Меко затворање



- Со целосно извлекување
- Со куглични лагери
- Со висина 45mm
- Носивост до 35kg

Шифра	H	L	Цена
90024	45mm	500mm	695 ден.

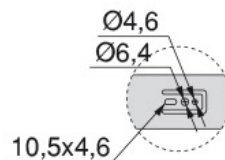
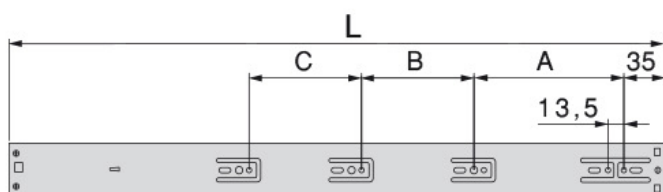
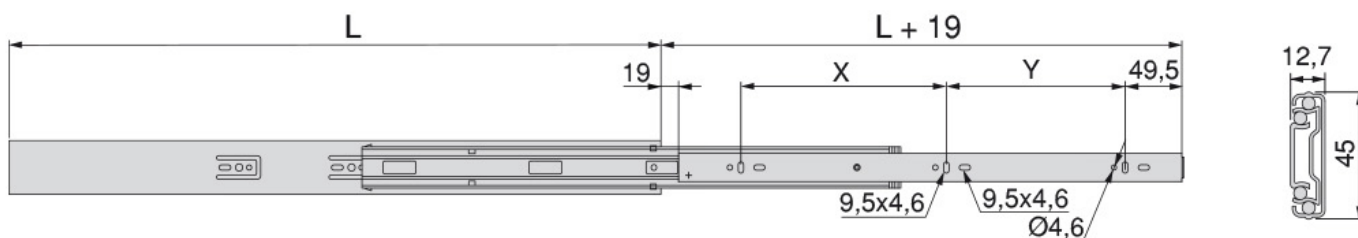

L	X	Y	A	B	C
500	192	192	128	96	64

С водилки



FIRA



- Сет водилки.
- Водилка со делумно извлекување
- Носивост до 20kg од сет.

Шифра	Н	Финиш	Цена
92809	250mm	Бел	97 ден.
92753	300mm	Бел	98 ден.
92697	350mm	Бел	99 ден.
90167	400mm	Бел	105 ден.
90166	450mm	Бел	127 ден.
90165	500mm	Бел	168 ден.
92696	600mm	Бел	198 ден.
92752	800mm	Бел	385 ден.
92698	500mm	Црн	179 ден.

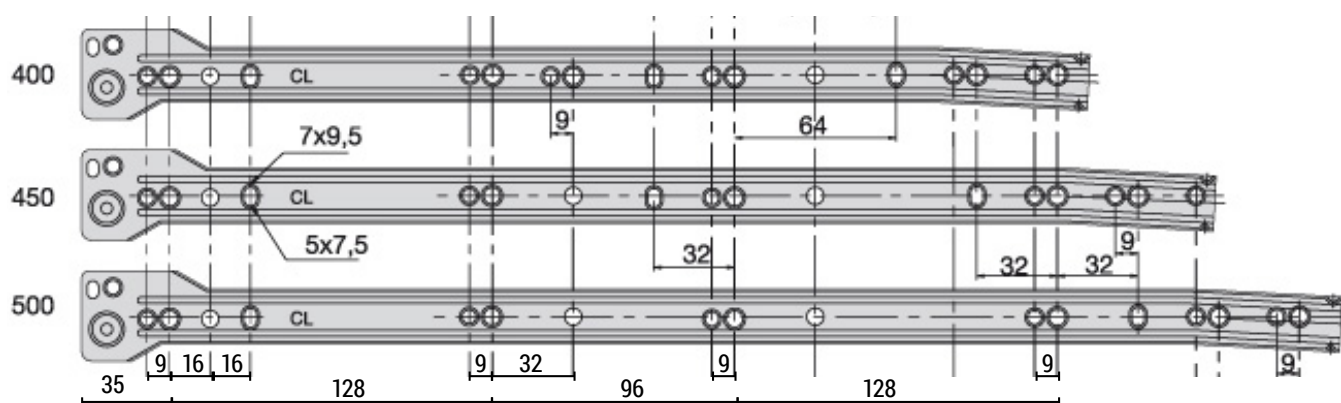



Silver soft водилки



- Лесна за монтажа и демонтажа
- 3D подесување: вертикално и длабинско подесување +/- 3mm, хоризонтално подесување +/- 1.5mm
- Вградено само-затворање и лев/десен клип
- Сетот одговара за лева/десна рака

Шифра	H	Цена
91782	290mm	599 ден.
91781	340mm	669 ден.
91780	390mm	709 ден.
91779	440mm	757 ден.
91778	490mm	815 ден.

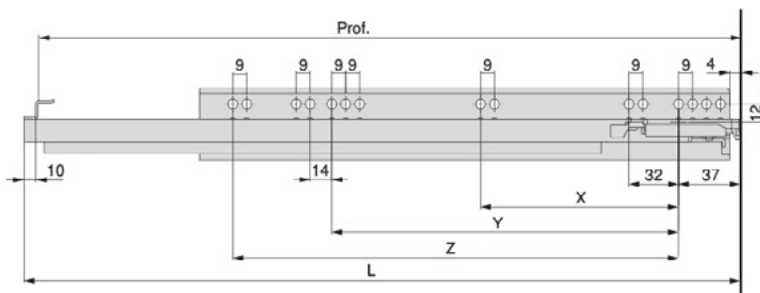
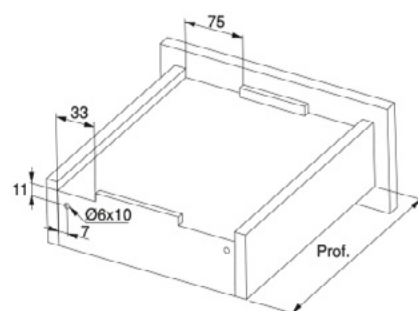
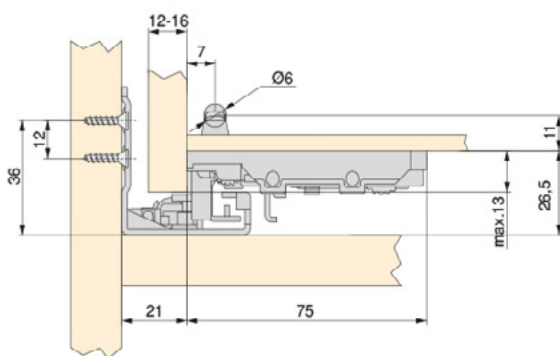

Prof	X	Y	Z	L
290	128	-	-	300
340	128	224	-	350
390	128	224	-	400
440	128	224	-	450
490	128	224	288	500

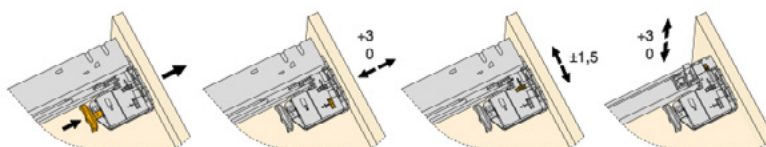

CONCEPT 105 фиоки со метална страница со меко затворање

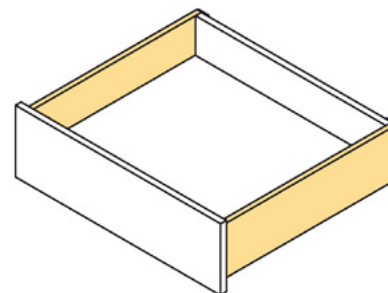
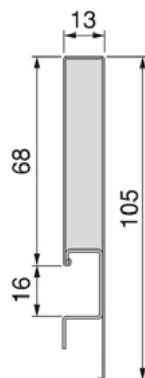

- Носивост до 30kg
- D=16mm дебелина на дно на фиока

Шифра	H	L	Финиш	Цена
7976	105mm	350mm	Бел	1.486 ден.
7970	105mm	350mm	Антрацит	1.523 ден.
7869	105mm	500mm	Бел	1.436 ден.
7897	105mm	500mm	Антрацит	1.572 ден.



CONCEPT 138 фиоки со метална страница со меко затворање

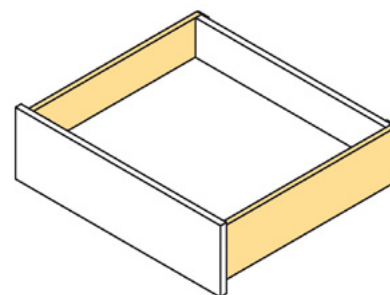

- Носивост до 30kg
- D=16mm дебелина на дно на фиока

Шифра	Н	L	Финиш	Цена
90512	138mm	300mm	Бел	1.659 ден.
90025	138mm	350mm	Бел	1.880 ден.
7971	138mm	350mm	Антрацит	1.768 ден.
90026	138mm	500mm	Бел	2.060 ден.
7966	138mm	500mm	Антрацит	2.100 ден.



CONCEPT 185 фиоки со метална страница со меко затворање

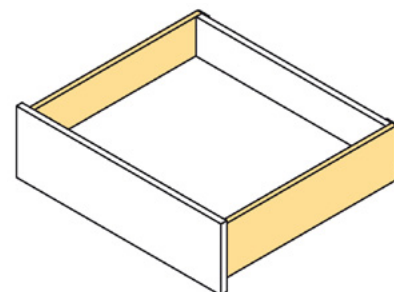

- Носивост до 30kg
- D=16mm дебелина на дно на фиока

Шифра	H	L	Финиш	Цена
90511	185mm	350mm	Бел	1.920 ден.
91031	185mm	350mm	Антрацит	1.931 ден.
7903	185mm	500mm	Бел	2.430 ден.
7867	185mm	500mm	Антрацит	2.395 ден.



CONCEPT релинг сет

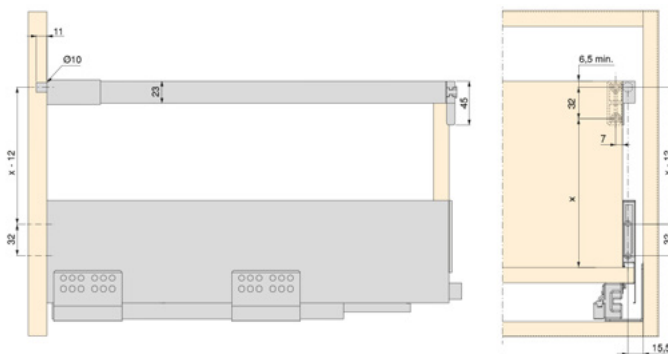

Шифра	L	Финиш	Цена
90769	500mm	Антрацит	375 ден.
90770	500mm	Бел	375 ден.

CONCEPT преден профил за внатрешна фиока

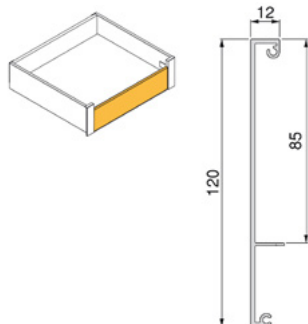
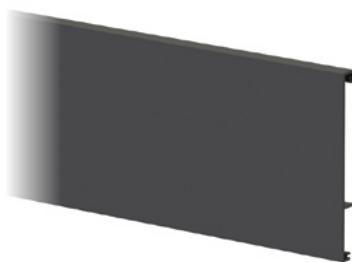

Шифра	L	Финиш	Цена
7977	1070mm	Антрацит	1.195 ден.
7972	1070mm	Бел	1.210 ден.

CONCEPT Сет држачи за фронтален профил на внатрешна фиока

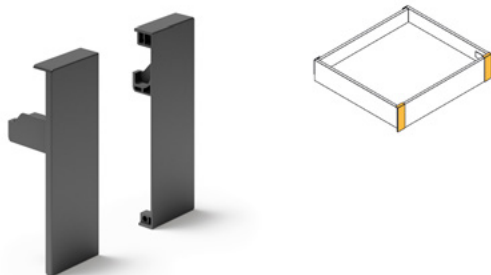

Шифра	H	Финиш	Цена
7961	105	Бел	234 ден.
7963	105	Сив	234 ден.
91834	138	Сив	257 ден.
91835	185	Сив	313 ден.

CONCEPT попречен релинг

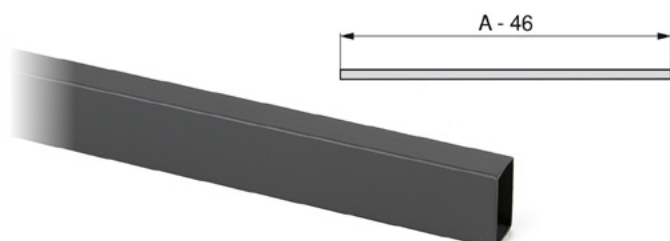

Шифра	Финиш	Цена
91826	Антрацит	510 ден.

SLIM правоаголен организатор за фиока под садопер

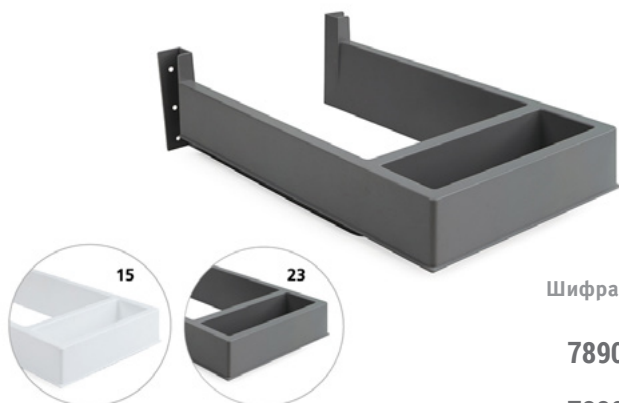

• Создаден за купатилски елементи за под мијалник, достапен во бела и сива пластика. Практично решение за максимална искористеност на елементот под мијалникот во тоалетот.

Шифра	Финиш	Цена
7890	Бел	272 ден.
7880	Антрацит	276 ден.

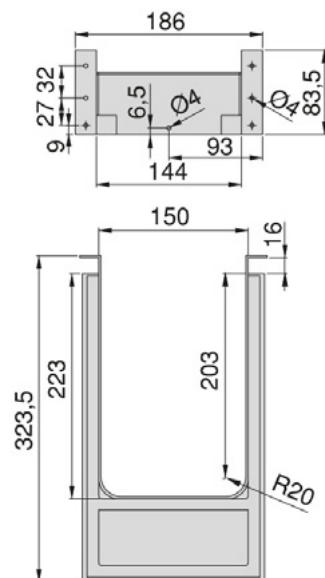

Заоблен организатор за фиока под садопер

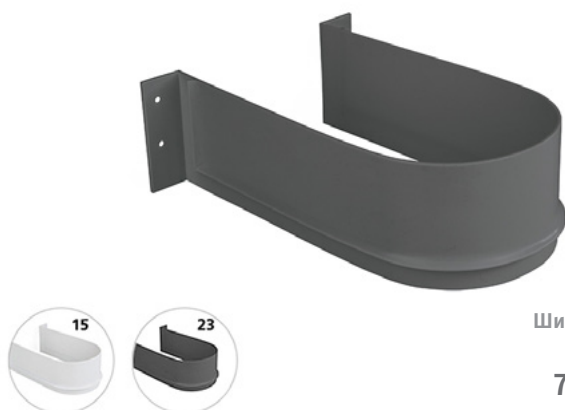

• Создаден за купатилски елементи за под мијалник, достапен во бела и антрацит пластика. Практично решение за максимална искористеност на елементот под мијалникот во тоалетот.

Шифра	Финиш	Цена
7964	Бел	173 ден.
7960	Антрацит	175 ден.

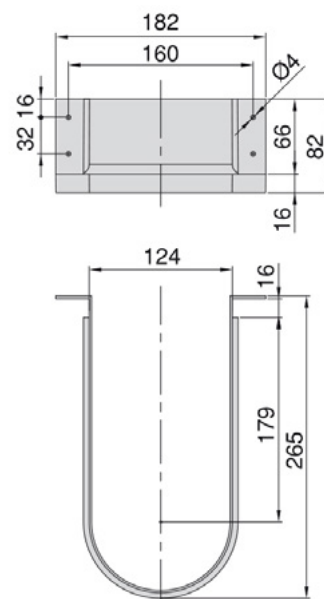

Anti-slip подлога за фиоки

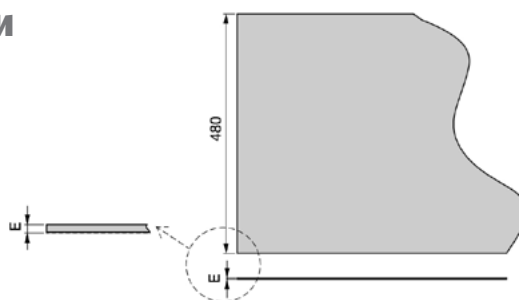
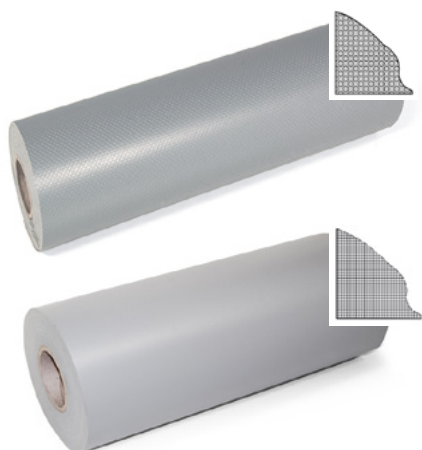

Шифра	Е	Ширина	Материјал	Финиш	Цена
91023	1,2	480mm	Гумена	Сив	463 ден.
91024	1,2	480mm	Текстилна	Црн	467 ден.
92068	1,2	480mm	Текстилна	Сив	435 ден.

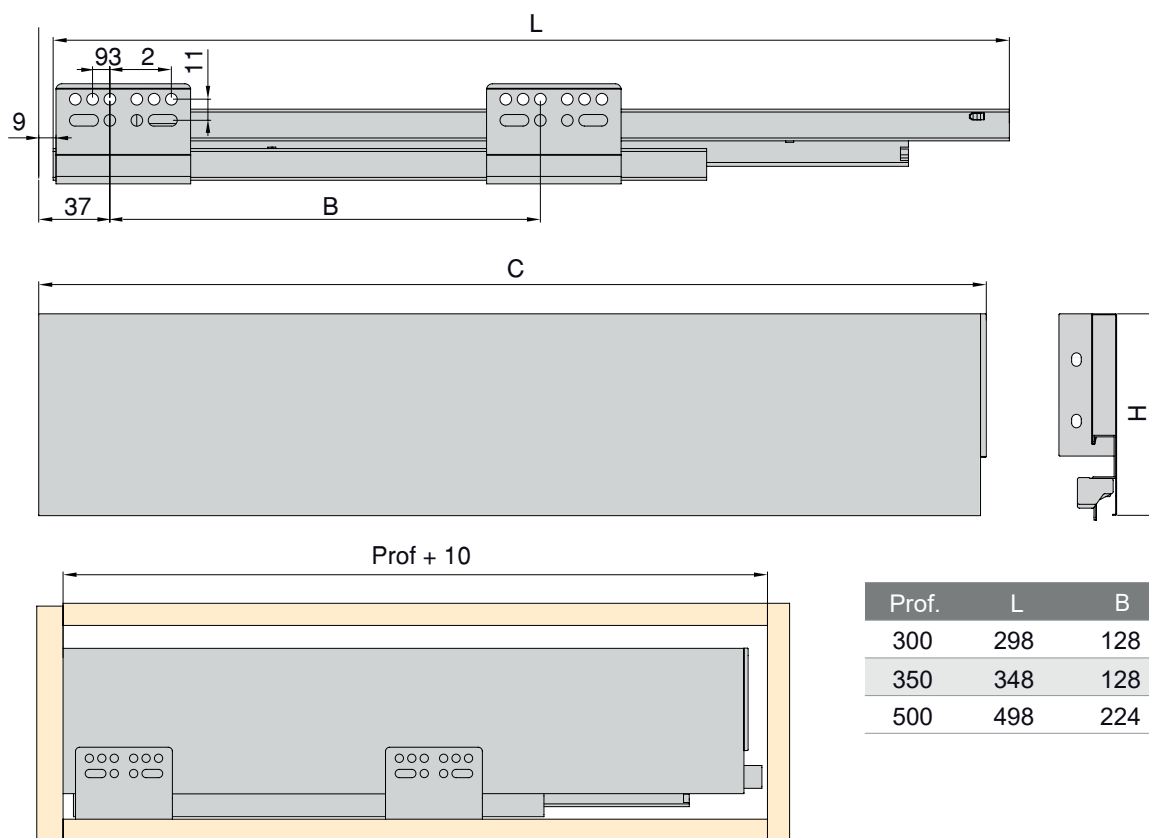

Prof.	L	B	C	H
300	298	128	293	105
350	348	128	343	138
500	498	224	493	185

Димензии на дно и позадина на фиока:

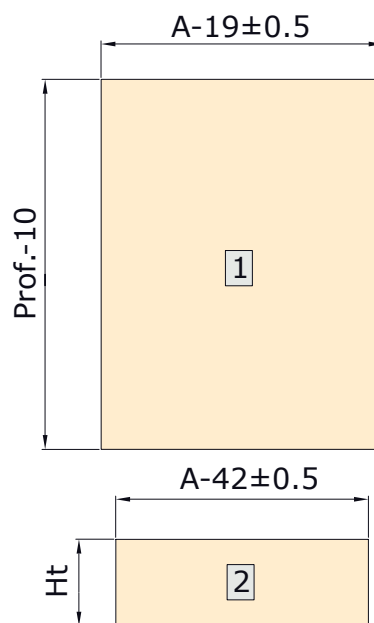
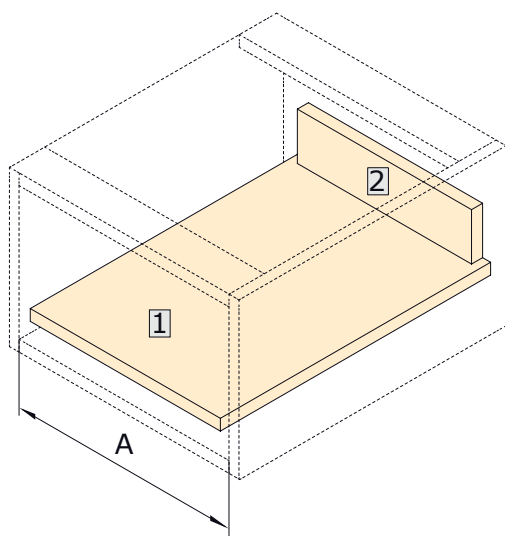

H	Ht
105	68
138	102
185	149

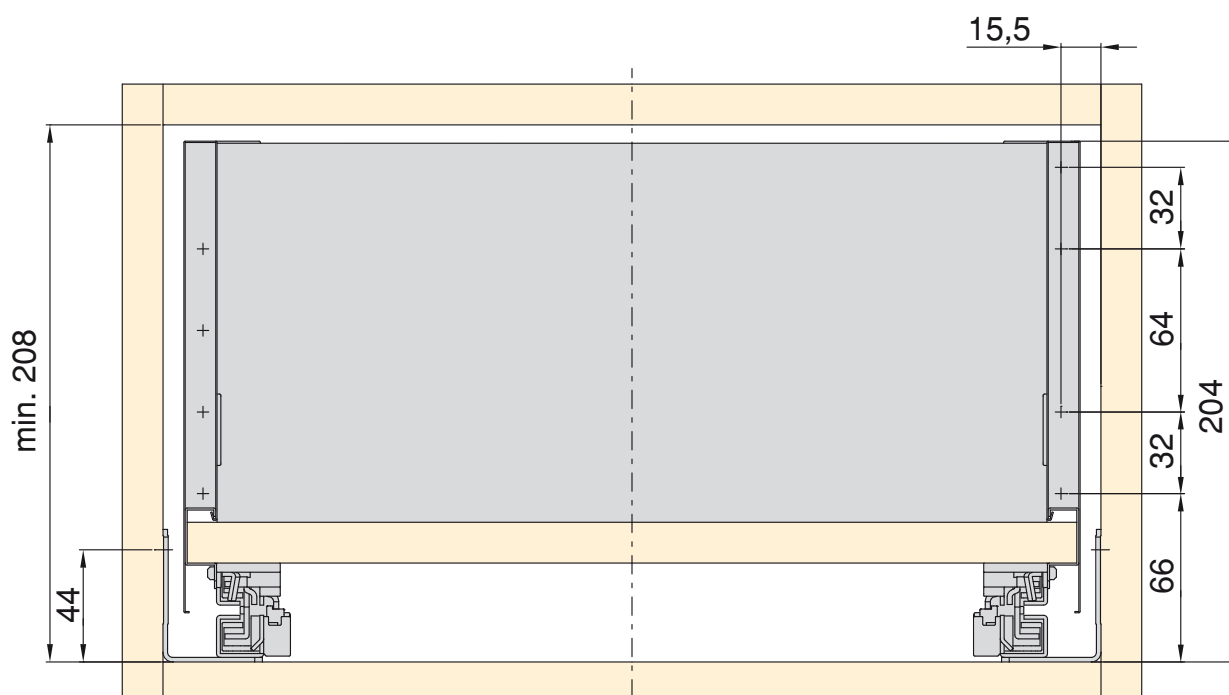
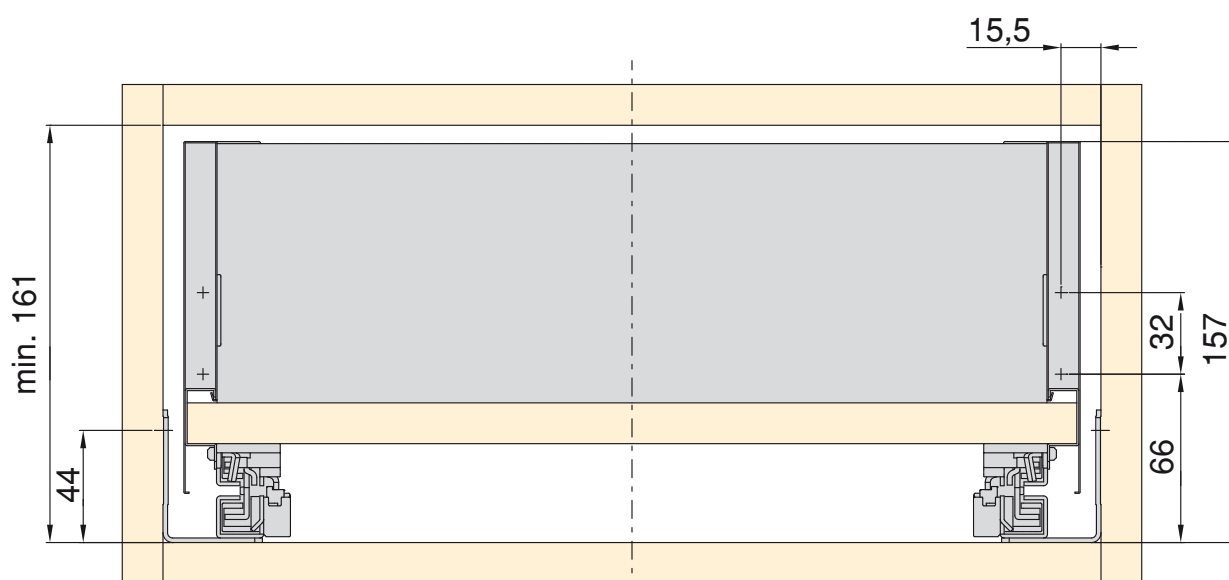
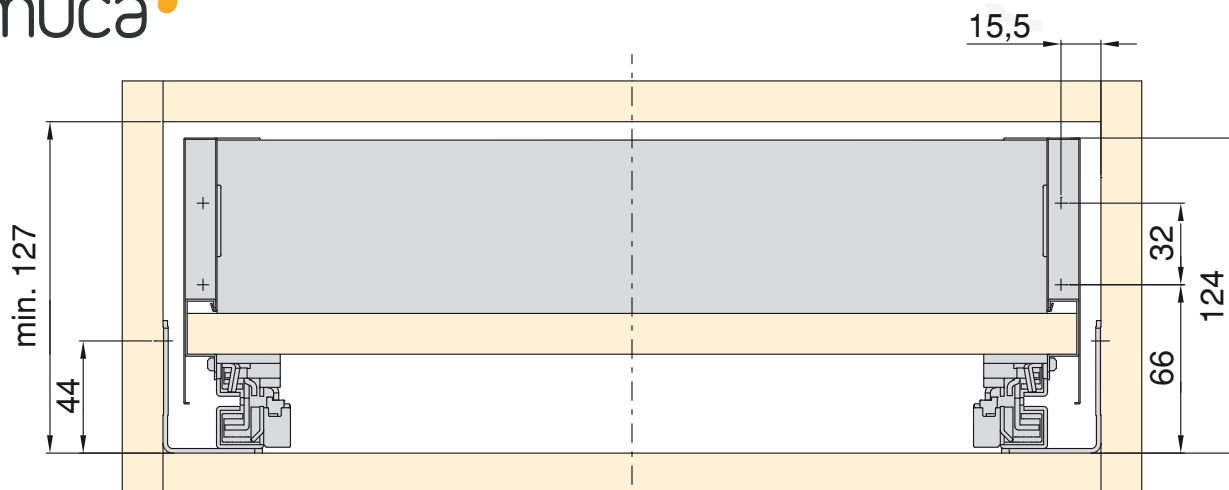



**Ногарки, тркалца
и канцелариски оков**

Ногара за мебел

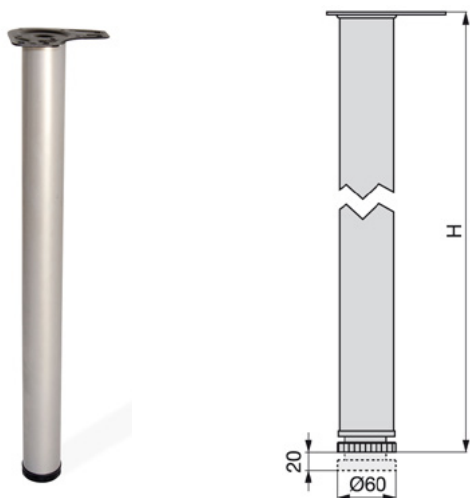

Шифра	Н	Ø	Финиш	Цена
7886	710mm	60	Бел	575 ден.
7877	710mm	60	Сребрен	588 ден.
7912	710mm	60	Црн	580 ден.

Кујнска ногара со база Ø48

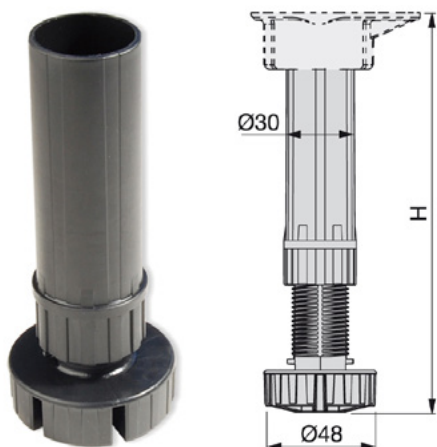

Држач за дрвено цокле

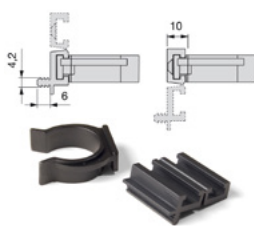

7718 | 9 ден.

Држач за ПВЦ цокле



7762 | 6 ден.

Штраф М10 за база Ø48

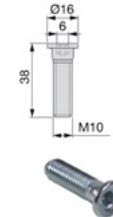

91692 | 9 ден.

База за ногара Ø48

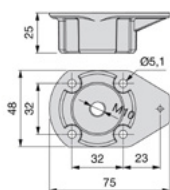

92251 | 10 ден.

Шифра	Н	Ø	Финиш	Цена
91690	56-66	48	Црн	34 ден.
91691	74-84	48	Црн	34 ден.
7727	100-130	48	Црн	25 ден.
7780	150-180	48	Црн	36 ден.

Ногарка со нивелатор Ø48

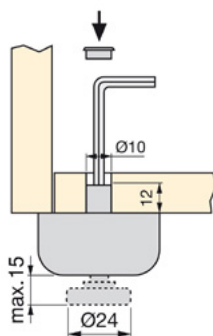
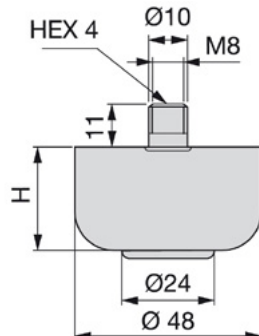

Шифра	Н	Финиш	Цена
1044	17mm	Црн	27 ден.
1045	27mm	Црн	29 ден.
3068	40mm	Црн	36 ден.

Нивелатор М6

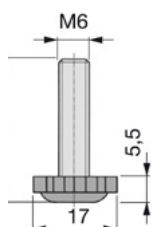

Шифра Ø Y Цена
90162 | 17mm | 25mm | 10 ден.

Нивелатор М8

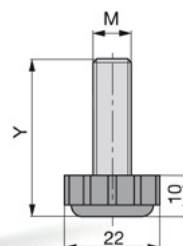

Шифра Ø Y Цена
90152 | 20mm | 38mm | 13 ден.

Нивелатор М6

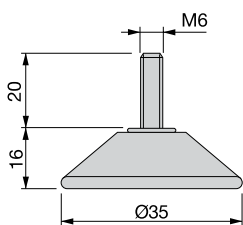

Шифра Ø Y Цена
92201 | 35mm | 20mm | 26 ден.

Нивелатор М8

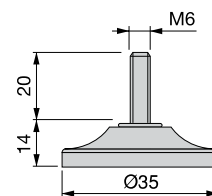

Шифра Ø Y Цена
92202 | 35mm | 20mm | 41 ден.

Матица

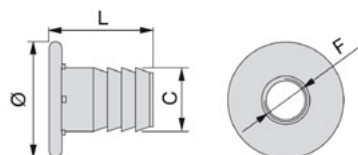

Шифра	L/mm	Ø/mm	C/mm	F/mm	Цена
90150	18	20	10.7	48	7 ден.
90144	15.4	13.6	8.7	48	6 ден.

Подлога теписон

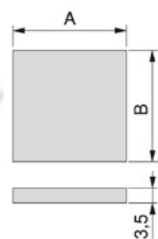

Шифра	A x B	Финиш	Цена
92070	25 x 25mm	Кафен	85 ден.
92250	30 x 30mm	Кафен	88 ден.



Шифра	A x B	Финиш	Цена
92071	250 x 100mm	Кафен	93 ден.



Шифра	Ø/mm	Финиш	Цена
92199	30	Кафен	85 ден.

Alumix 1 ногара за мебел

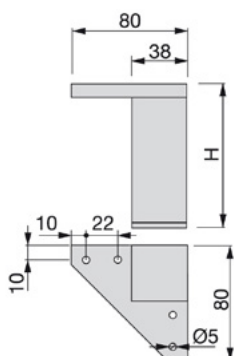

Шифра	Н/мм	Финиш	Цена
7879	80	Сребрен	60 ден.
7874	100	Сребрен	63 ден.
7888	120	Сребрен	89 ден.

Alumix 7 ногара за мебел

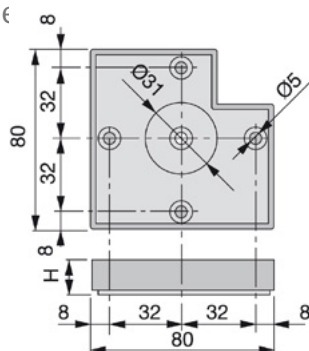

Шифра	Н/мм	Финиш	Цена
7878	15x80	Сребрен	57 ден.
7872	30x80	Сребрен	79 ден.
7914	45x80	Сребрен	105 ден.

Alumix 8 ногара за мебел

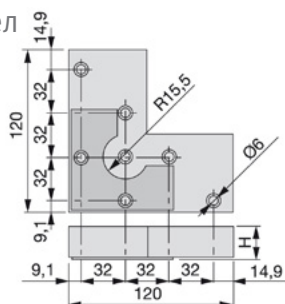

Шифра	Н/мм	Финиш	Цена
7885	24x120	Сребрен	108 ден.

Pipe 4 Маска за кабли

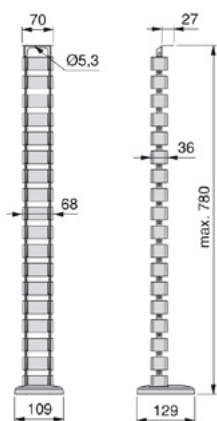

Шифра	Финиш	Цена
90838	Сребрен	1.819 ден.

Розетна за кабли кружна

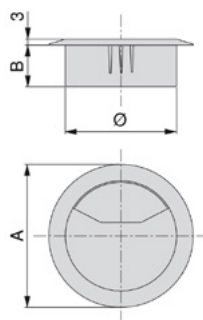

Шифра	A	B	Ø	Финиш	Цена
7116	71	16	60	Бел	34 ден.
7119	71	16	60	Крем	34 ден.
3273	71	16	60	Сив	34 ден.
7120	71	16	60	Црн	34 ден.
92079	71	16	60	Хром мат	269 ден.

Розетна за кабли квадратна

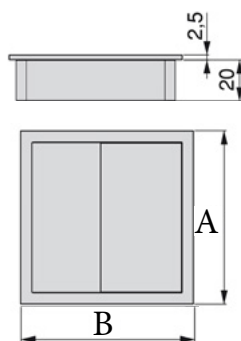

Шифра	A	B	Финиш	Цена
92537	85	85	Црн	247 ден.
92529	85	85	Бел	238 ден.
92528	152	61	Бел	258 ден.
92553	152	61	Црн	262 ден.

Тркало за мебел со кочница Ø50

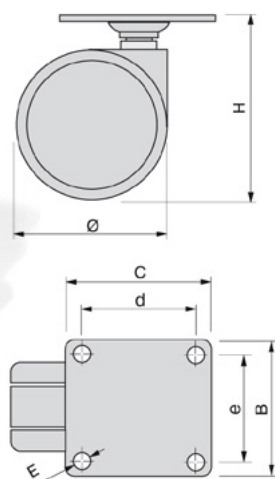

H	55
CxВ	38x38
d x e	25x25
E	5,5

- Со кочница
- Димензија: Ø50mm
- Финиш: Сив
- Носивост: 50kg

7893 | 169 ден.

- Без кочница
- Димензија: Ø50mm
- Финиш: Сив
- Носивост: 50kg

90027 | 143 ден.

Тркало за мебел Ø30

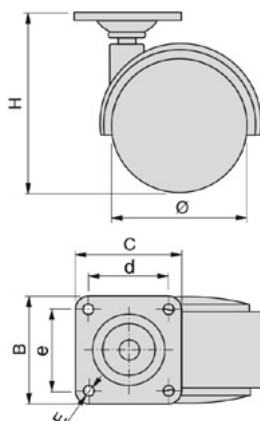

H	44
CxВ	30x30
d x e	20x20
E	4,5

- Без кочница
- Димензија: Ø30mm
- Финиш: Црн
- Носивост: 15kg

7871 | 24 ден.

Тркало за мебел Ø40

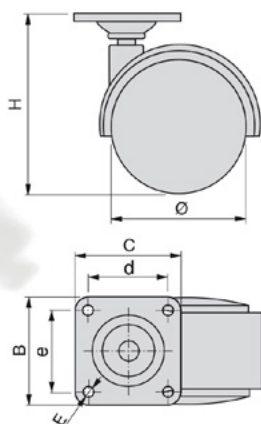

H	55
CxВ	38x38
d x e	25x25
E	5,5

- Со кочница
- Димензија: Ø40mm
- Финиш: Црн
- Носивост: 25kg

7868 | 49 ден.

- Без кочница
- Димензија: Ø40mm
- Финиш: Црн
- Носивост: 25kg

7908 | 33 ден.

Тркало за мебел Ø50

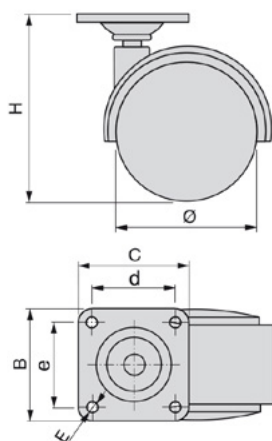

H	65
CxВ	38x38
d x e	25x25
E	5,5

- Без кочница
- Димензија: Ø50mm
- Финиш: Црн
- Носивост: 30kg

7864 | 48 ден.

- Со кочница
- Димензија: Ø50mm
- Финиш: Црн
- Носивост: 30kg

7889 | 56 ден.

Тркало за мебел Ø80

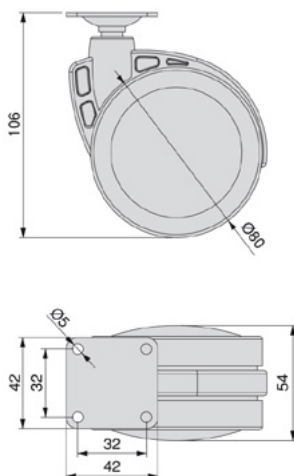

- Без кочница
- Димензија: Ø80mm
- Финиш: Сив
- Носивост: 50kg

7901 | 239 ден.

- Со кочница
- Димензија: Ø80mm
- Финиш: Сив
- Носивост: 50kg

7896 | 271 ден.



Тркало за мебел Ø50

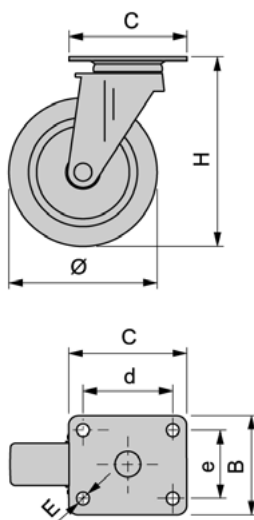

H	64
CxВ	42x42
d x e	32x32
E	4,5

- Без кочница
- Димензија: Ø50mm
- Финиш: Сив/Црн
- Носивост: 35kg

7876 | 172 ден.

- Со кочница
- Димензија: Ø50mm
- Финиш: Сив/Црн
- Носивост: 35kg

7911 | 211 ден.

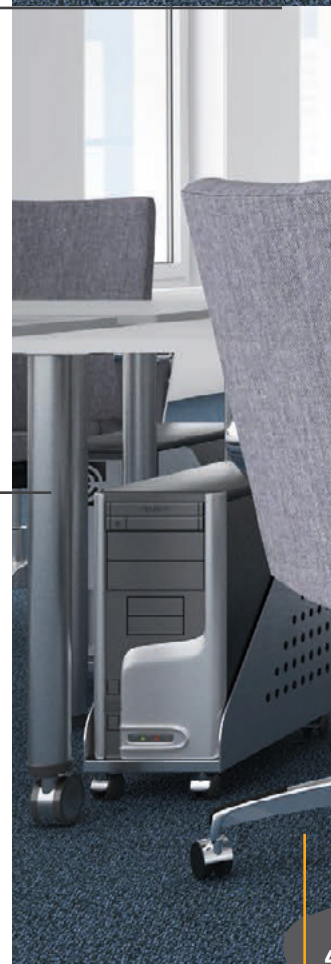

Тркало силиконско Ø50

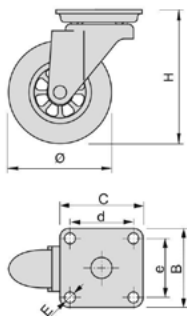

- Лесна монтажа
- Висина(H): 63mm
- Димензија(Ø): Ø50mm
- Носивост: 40kg
- C_X_B: 42 x 42mm
- D_X_E: 32 x 32mm
- Финиш: Транспарент
- Челик, пластика

- Без кочница

92695 | **215** ден.

- Со кочница

92694 | **246** ден.

Caster сет тркало 2+2 Ø50

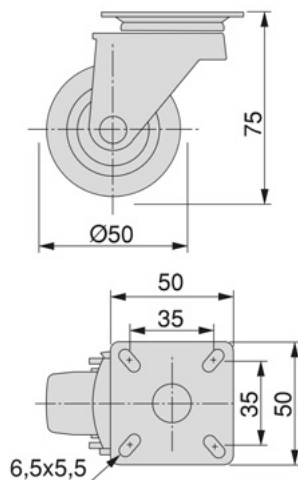

- Caster сетот, од 4 тркала, е дизајнирано за секакви домашни мебели, за канцелариски елементи и за детски мебел
- Сетот е составен од 4 тркала: 2 тркала со кочница и 2 тркала без кочница
- Лесна монтажа
- Димензија: Ø50mm
- Носивост: 35kg/по тркало
- Финиш: Црн



92400 | 677 ден.

Caster сет тркало 2+2 Ø75

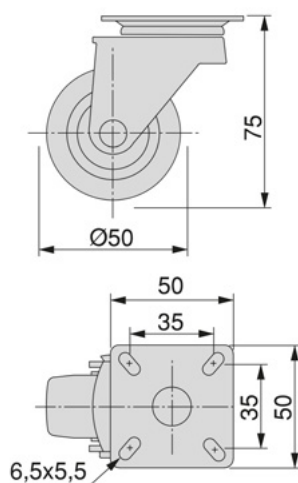

- Caster сетот, од 4 тркала, е дизајнирано за секакви домашни мебели, за канцелариски елементи и за детски мебел
- Сетот е составен од 4 тркала: 2 тркала со кочница и 2 тркала без кочница
- Лесна монтажа
- Димензија: Ø75mm
- Носивост: 40kg/по тркало
- Финиш: Црн



92401 | 1.076 ден.

Држач за монитор - моно

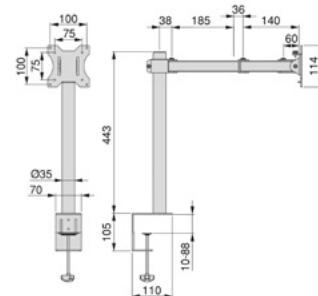

- Држач за монитор (13 - 32" и тежина до 8 kg)

- Ротација на монитор + 90° / - 90° (Portrait/ Landscape), ротација на помошен зглоб 180° и ротација главен зглоб 360°.

- Осовинскиот држач е со променлива должина, со помошен зглоб може да биде до 470mm. Вклучува канали за каблите за да останат скриени и организирани.

- За панели со дебелина од 10mm до 88mm. Може да се монтира на ивицата на маса.

- Монтажните инструкции и имбус се вклучени.



92533 | 2.849 ден.

Држач за монитор - дупли

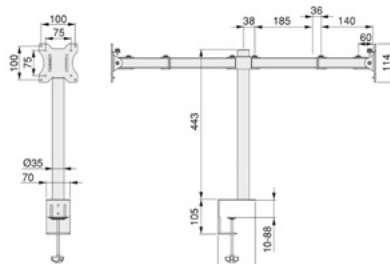

- Држач за два монитори (13 - 32" и тежина до 8 kg по осовина)

- Ротација на монитор + 90° / - 90° (Portrait/ Landscape), ротација на помошен зглоб 180° и ротација главен зглоб 360°.

- Осовинскиот држач е со променлива должина, со помошен зглоб може да биде до 430mm. Вклучува канали за каблите за да останат скриени и организирани.

- За панели со дебелина од 10mm до 88mm. Може да се монтира на ивицата на маса.

- Монтажните инструкции и имбус се вклучени.



92532 | 3.551 ден.

Држач за ТВ - ротирачки 90°

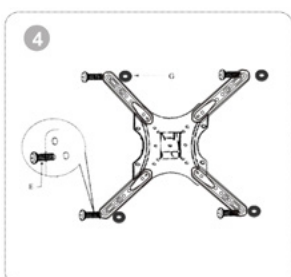
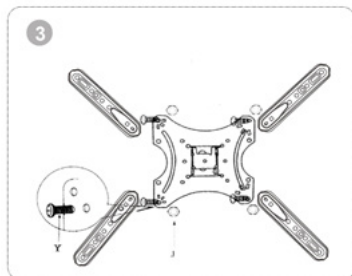
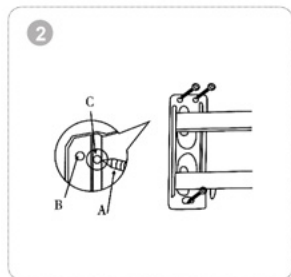
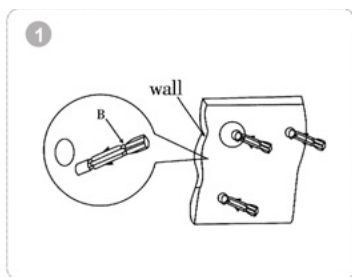
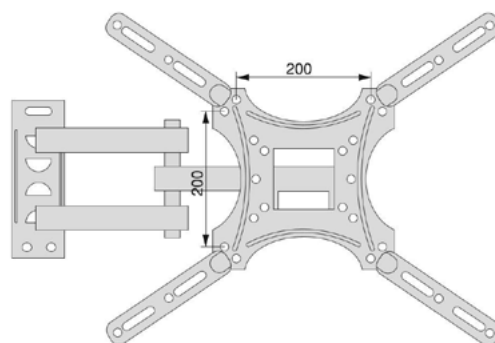

- ▶ За ТВ од 14 до 55 инчи, со носивост до 32kg
- ▶ Ротира 90° лево/десно и се навалува 5° нагоре и 15° надолу за удобна прегледност.
- ▶ Може да се оддалечува од ѕид од 32 до 402mm.
- ▶ Во сетот се приклучени сите потребни завртки за монтирање на системот на ѕид и на ТВ.
- ▶ Челик, црн.

92558 | 1.190 ден.

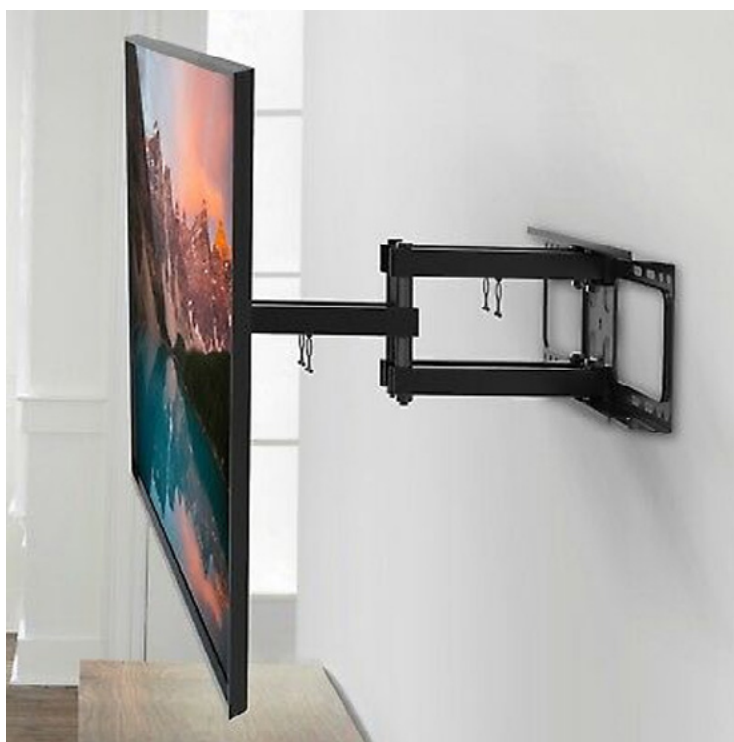

Lift Vision - лифт за ТВ

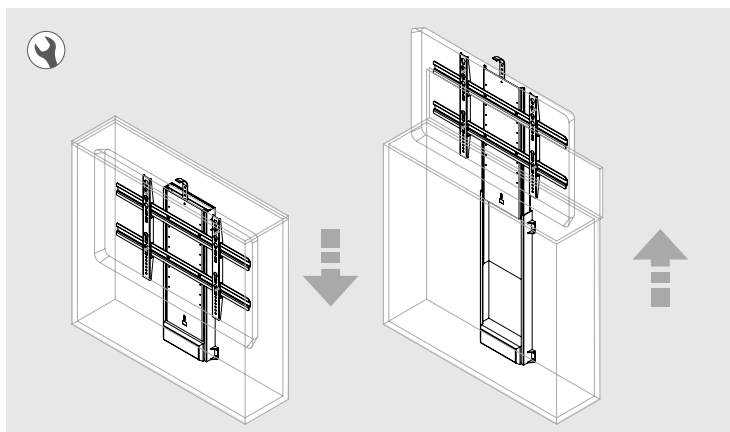
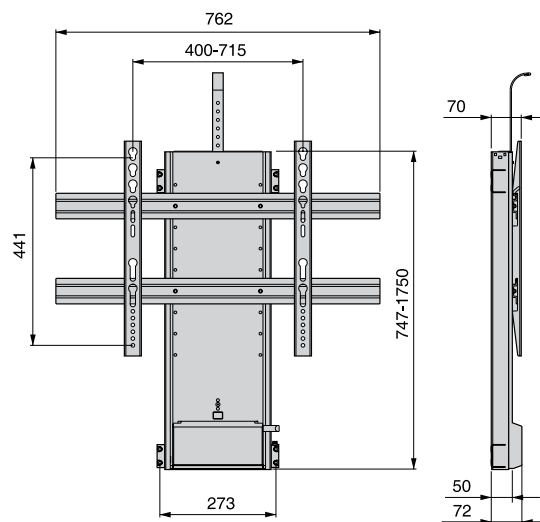

- ▶ Моторизан лифт-држач за подигање на ТВ, со мануелна и далечинска команда.
- ▶ Поддршка електрична од 110-240 VAC / 50-60Hz.
- ▶ Вклучува и тип G адаптер.
- ▶ Механизам за повлекување за избегнување на можни пречки при спуштање на ТВ.
- ▶ Носивост од 5-100кг.
- ▶ Компатибилен за телевизори 200x100 - 200x200 - 300x300 - 400x100 - 400x200 - 400x400 - 600x100 - 600x200 - 600x400

Цена
92069 | **61.999** ден.



Штраф за екцентар

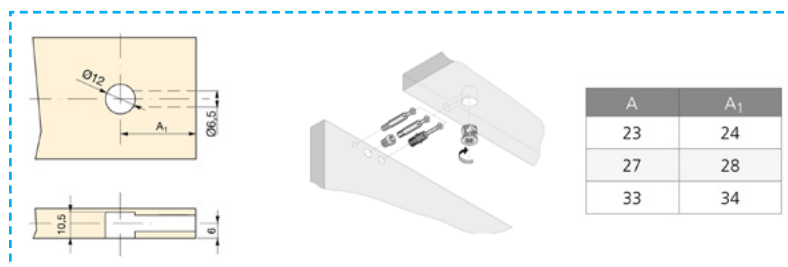

A	A ₁
23	24
27	28
33	34

A	23
Z	9
F	Ø6

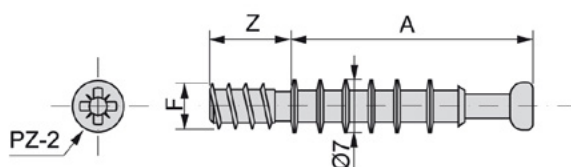

Шифра	Димензија	Финиш	Цена
7713	7 x 33 x 6mm	Цинк	4 ден.
91014	8 x 24 x 6mm	Цинк	8 ден.

Екцентар D15 / SP16 за 16mm дебелина

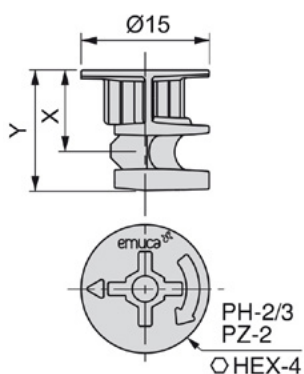

X	8
Y	12,5

Шифра	Финиш	Цена
7767	Цинк	4 ден.
7765	Кафен	4 ден.

Екцентар D15 / SP18 за 18mm дебелина

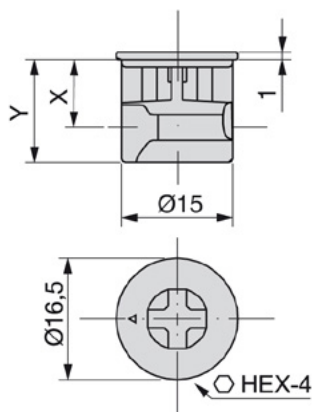

X	9
Y	14

Шифра	Финиш	Цена
7769	Цинк	5 ден.

Носач за полица Ø20мм метален



Штраф Ф6х8-цинк

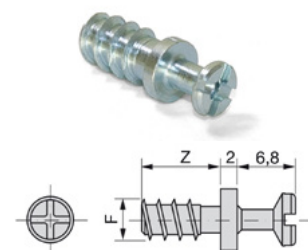

90519 | Ø6 x 8mm | 6 ден.

90518 | 22 ден.

Типла дрвена



Шифра	Ø	X/mm	Материјал	Цена
7753	8	30	Дрво	1 ден.

Конформат штраф 5х50мм имбус

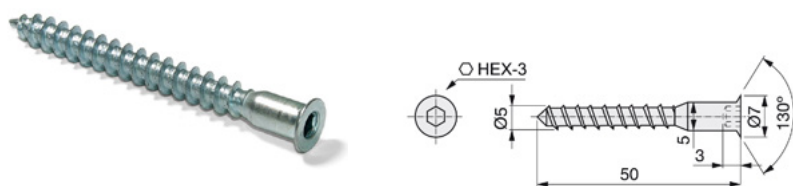

Шифра	Финиш	Цена
1110	Никел	2 ден.
90694	Црн	2 ден.

Еуро штраф

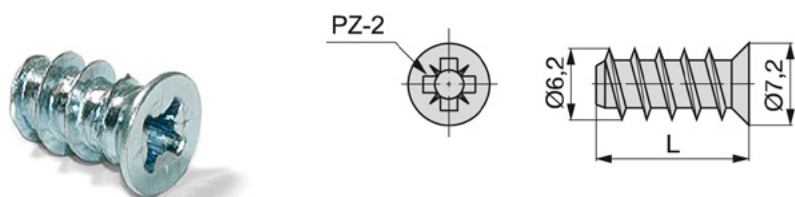

Шифра	Димензија/mm	Материјал	Цена
7717	6.2 x 13	Никел	2 ден.

Еуро штраф

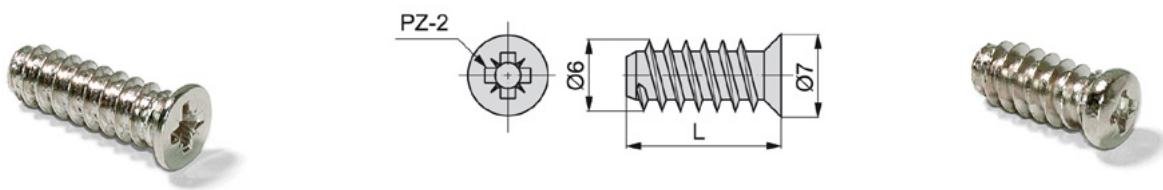

90687 | L 13,7mm | Цена 2 ден.

92072 | L 13mm | Цена 3 ден.

Типла М4 ПВЦ Ø8mm

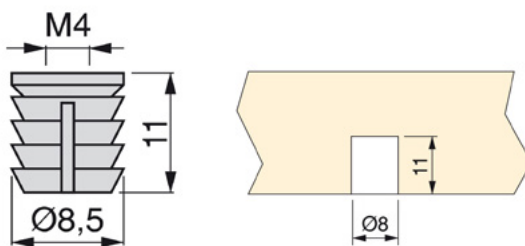

90151 | 3 ден.

Типла М6 ПВЦ Ø10mm

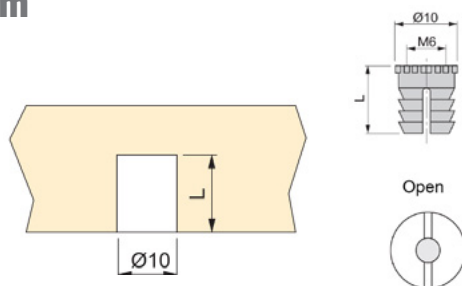

91015 | 2 ден.

Типла ПВЦ Ø5mm L=11mm

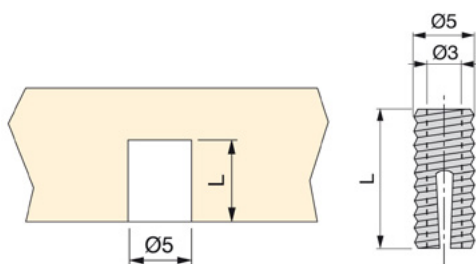

91022 | 1 ден.

Метален аголник

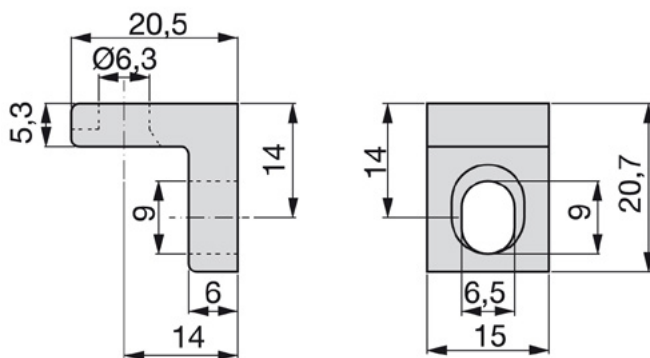

Димензија
7738 | 20.5 x 20.7mm | Цена
17 ден.

Метален аголник

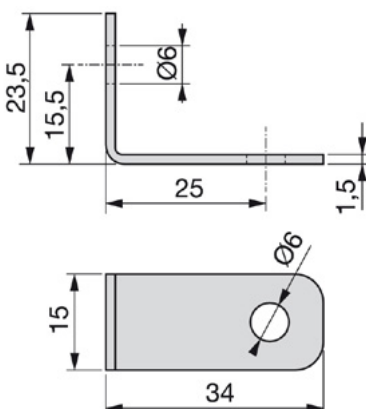
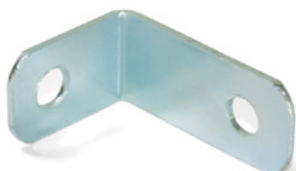

Шифра
7754 | Димензија
34 x 23.5mm | Цена
6 ден.

Метален аголник

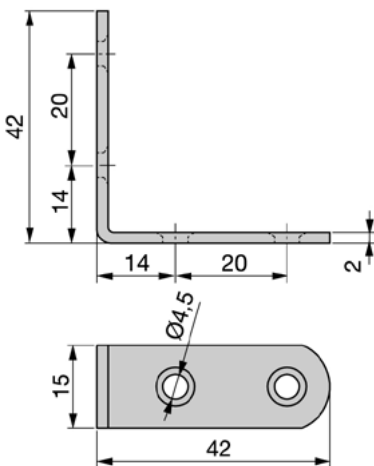

Шифра
7712 | Димензија
42 x 42mm | Цена
7 ден.

Метален аголник

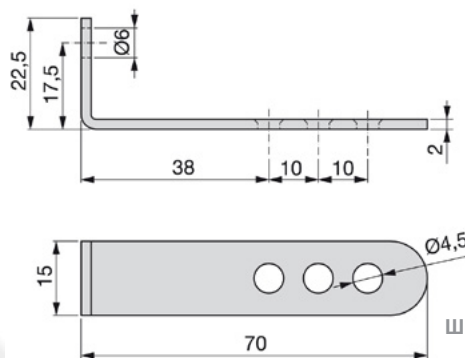
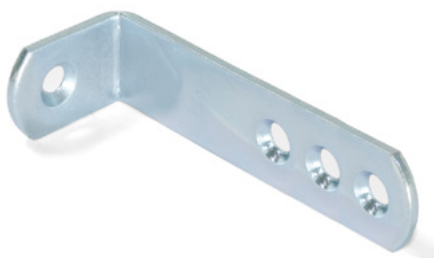

Шифра
7747 | Димензија
70 x 22.5mm | Цена
13 ден.

Штраф М4

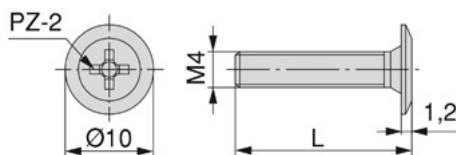

Шифра	Финиш	Цена
7686	20	2 ден.
7968	22	2 ден.
7760	40	3 ден.

Комплет спојници

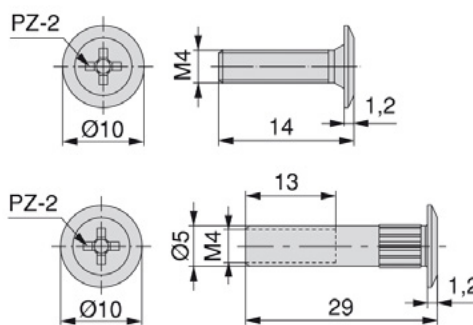

- Комплетот содржи:
L=29mm x M4
14 штраф М4

7751 | 5 ден.

Носач на полица Ø5

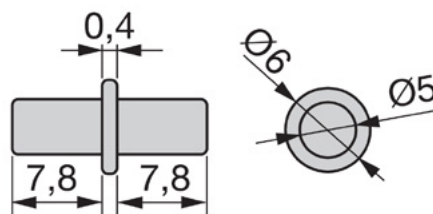

7756 | 1 ден.

Носач на полица Ø5

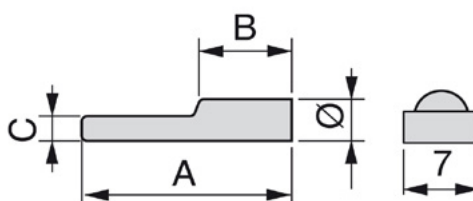

7779 | 2 ден.

Носач на полица $\varnothing 5$ СПЛ транспарентен

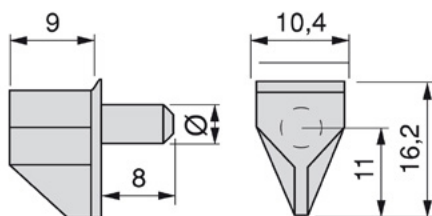

2851 | 2 ден.

Носач на полица $\varnothing 20$ x 13mm /16-19mm

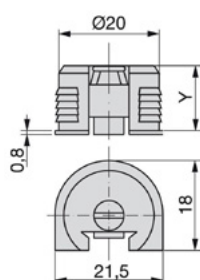

92296 | 9 ден.

Носач на стаклена полица $\varnothing 5$ со гума

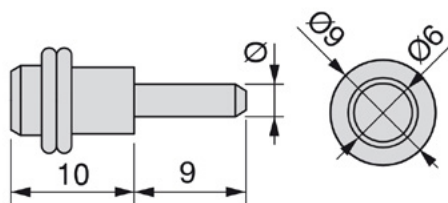

7724 | 6 ден.

Носач на стаклена полица $\varnothing 5$

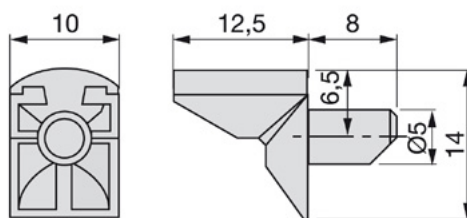

7688 | 7 ден.

Носач на стаклена полица $\varnothing 5/6-8$ mm

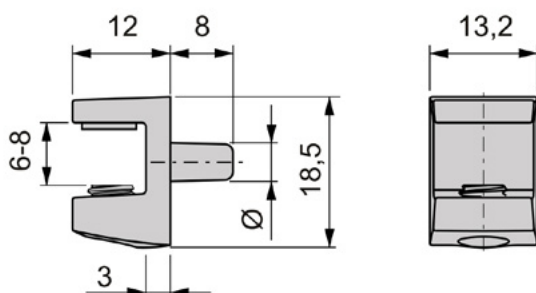

90149 | 32 ден.

Држач за стакло/позадина

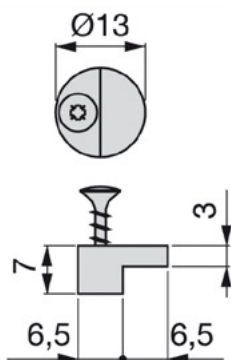

91138 | 4 ден.

Одбојник

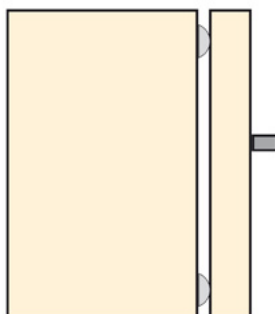
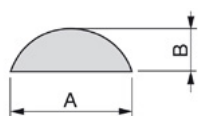

	A/mm	B/mm	
90652	10	1.5	99 ден.
92554	10	3	95 ден.
92555	7	1.5	109 ден.

Одбојник со бушење

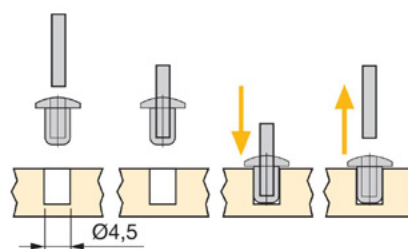
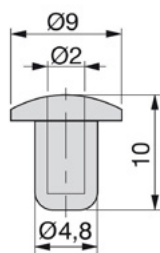

92556 | Транспарентен | 148 ден.

Спојник за носач на полица 16

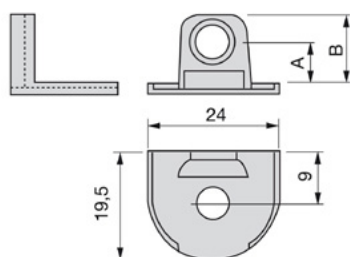

92295 | 11 ден.

Phantom скриен држач за полици

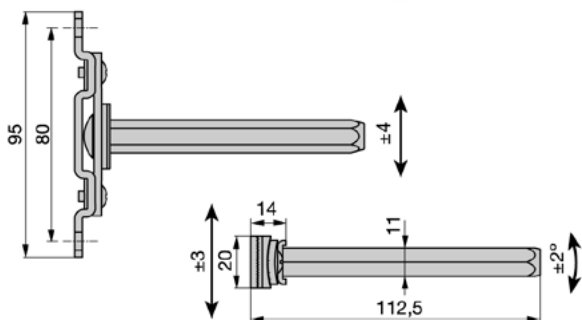

- Метален скриен држач на полици
- 3D подесување
- Максимум носивост за 2 држачи:
20Kg за полици од 900x300mm,
15Kg за полици од 900x350mm.
- Употребете 3 држачи за полици подолги од 900mm
- Максимум далечина измеѓу држачите 700mm

Шифра | L | Цена
7882 | 125mm | 305 ден.

Сет држачи со шина за висечки елементи

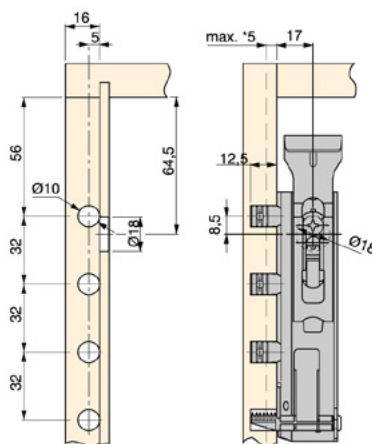

- Носивост: 65kg
- Комплетот содржи:
- Лев држач
- Десен држач
- Профил за висечки елементи
- Шина

7698 | 315 ден.

HOLDY

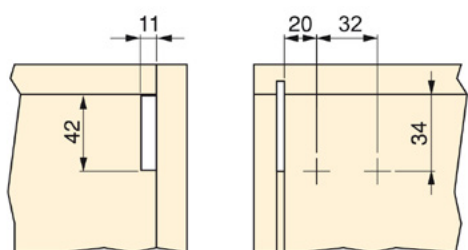
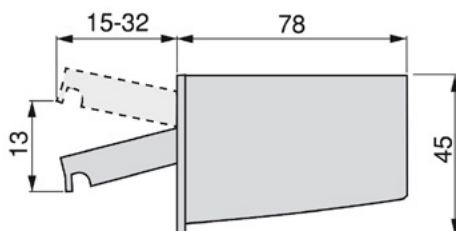

- Држач за висечки елементи на шина

Шифра	Димензија	Цена
7965	Десна	72 ден.
7967	Лева	72 ден.

Носач за висечки елементи на шина

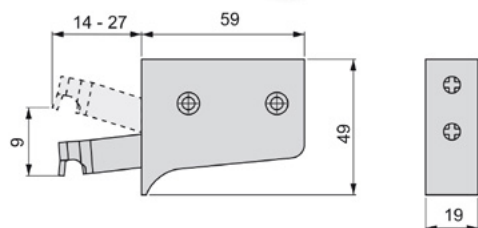
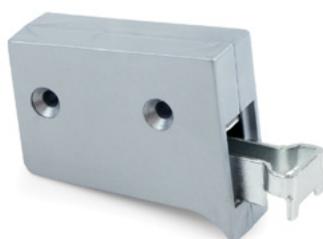

- Видлива закачалка без страни
- Максимум носивост 35kg
- Подесување на фронтот
- Подесување на длабочината 13mm
- Подесување на висината 9mm
- Препорачливата завртка Ø 3,5 x 30mm

7691 | 41 ден.

HOLDY капаче



7980	Десна	бел	13 ден.
7962	Лева	бел	13 ден.
92197	Десна	Антрацит	13 ден.
92196	Лева	Антрацит	13 ден.

Anti-tilt стабилизатор



Шифра	Позиција	Цена
92203	Десна	14 ден.
92204	Лева	14 ден.





Носач на полица со преклоп



- ▶ Носач на полица со преклоп
- ▶ Должина на носачот: 400mm. Максимална носивост до 60kg за два механизми
- ▶ Систем за заглавување за заштита од случајно преклопување
- ▶ Лесна монтажа со завртки
- ▶ Челик, бел.

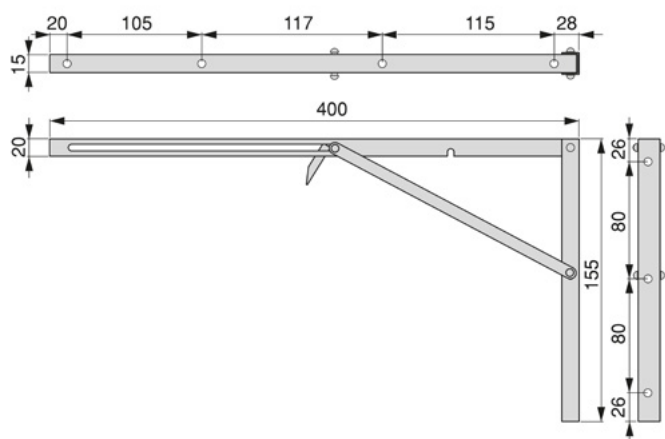

Шифра	Димензија/мм	Финиш	Цена
92560	300x 155x 1,5	Бел	452 ден.
92559	400x 215x 1,5	Бел	559 ден.

Профил шина за висечки елементи

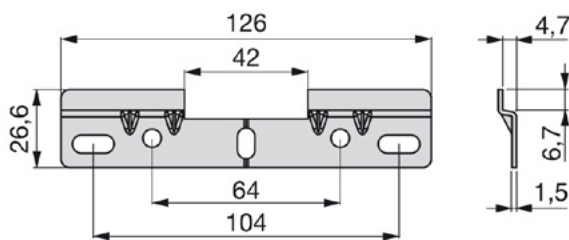
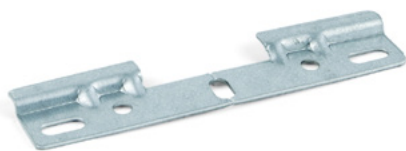

7759 | 30 ден.

Шина за висечки елементи

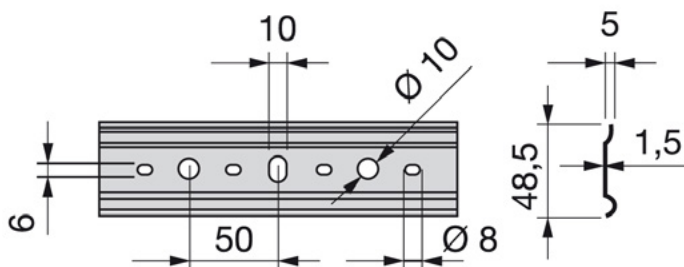

Шифра	L	Цена
7693	2m	225 ден./ком.

Метален аголник за маса



Шифра	Димензија	Цена
7981	86 x 52mm	69 ден.

Плочка метална

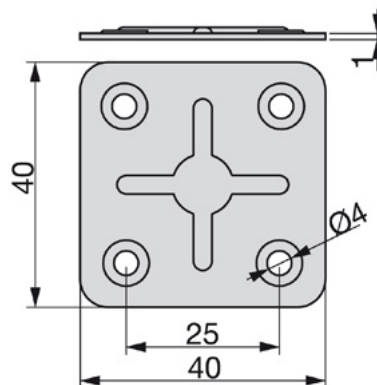

7720 | 5 ден.

Лепенки

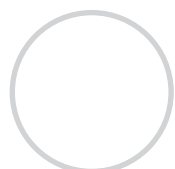

бела

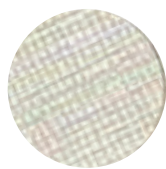

сив текстил



даб



сива

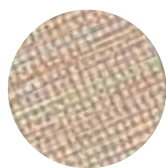

беж текстил

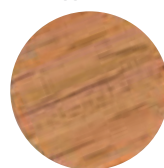

бука

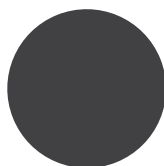

Антрацит



багрем

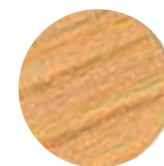

бор

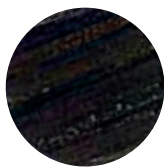

венге



беж



цреша

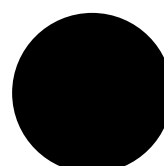

црна

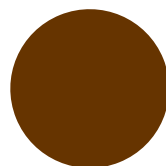

кафена



пепел

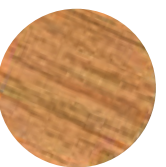

даб

Ø13 - 20/1

Шифра	Финиш	Цена
7716	беж	25 ден.
7697	беж текстил	25 ден.
7675	бор	25 ден.
7701	бука	25 ден.
7735	венге	25 ден.
7722	сив текстил	25 ден.
7695	сива	25 ден.
7705	цреша	25 ден.
90145	антрцит сива	25 ден.
90146	кафена	25 ден.
90147	бела	25 ден.
90148	даб	25 ден.
90287	багрем	25 ден.
91823	црна	25 ден.
92690	пепел	25 ден.

Ø20 - 15/1

Шифра	Финиш	Цена
7725	беж	35 ден.
7715	беж текстил	35 ден.
7770	бела	35 ден.
7680	бука	35 ден.
7758	венге	35 ден.
7732	даб	35 ден.
7690	кафена	35 ден.
7687	багрем	35 ден.
7681	сива	35 ден.
7706	сив текстил	35 ден.
7704	цреша	35 ден.
7714	црна	35 ден.
91824	антрацит	35 ден.

emusa 



**Системи за лизгачки
врати и додатоци**

1.



- За врата Slowmove
- Макс. носивост: 70kg

7771 | **425 ден.**



- Сет за врата со меко

7674 | **30kg | 1.085 ден.**

7766 | **50kg | 1.150 ден.**



- Сет тркалца за врата и стопер.
- Носивост: 70kg

7707 | **880 ден.**



- Долно тркало за врата

92080 | **252 ден.**

2. **PLACARD 81** Горна шина

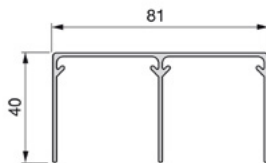

Шифра	Финиш	L	Цена
91694	Елоксиран мат	2.35m	2.007 ден. /ком.
92802	Елоксиран мат	3.9m	3.365 ден. /ком.
7703	Брусен челик	3m	2.955 ден. /ком.

3. **PLACARD 81** Долна шина

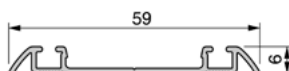

Шифра	Финиш	L	Цена
91696	Елоксиран мат	2.35m	585 ден. /ком.
91762	Елоксиран мат	3.5m	905 ден. /ком.
92812	Елоксиран мат	3.9m	1.288 ден. /ком.

PLACARD 81 Маска за Долна шина

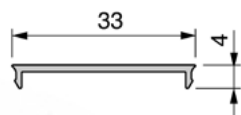

Шифра	Финиш	L	Цена
91973	Елоксиран мат	2.35m	410 ден. /ком.
91750	Елоксиран мат	3.5m	685 ден. /ком.
92803	Елоксиран мат	3.9m	755 ден. /ком.
7673	Брусен челик	3m	728 ден. /ком.

PLACARD Гума за исполна

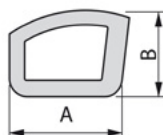

Шифра	Финиш	A	B	Цена
90139	Бел	14mm	10mm	126 ден. /м.



4. WAVE18

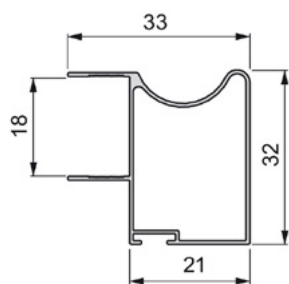

Шифра	Финиш	L	Цена
7700	Елоксиран мат	2.9m	960 ден.
7776	Брусен челик	3m	1.778 ден.

SHARP18E

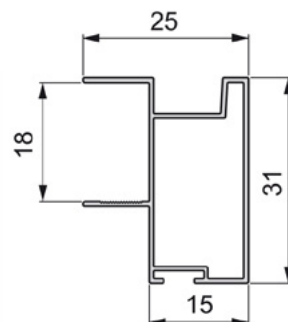

Шифра	Финиш	L	Цена
7733	Елоксиран мат	2.9m	653 ден.

WAVE18E

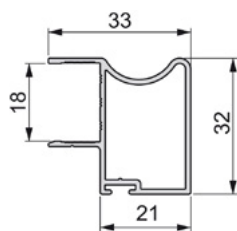

Шифра	Финиш	L	Цена
7689	Елоксиран мат	2.9m	610 ден.

QUAD18

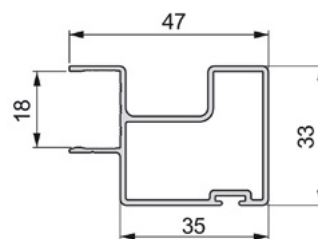

Шифра	Финиш	L	Цена
90155	Елоксиран мат	3m	1.588 ден.

*Цената се однесува на должен метар

DEEP18 профил

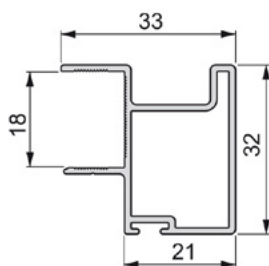
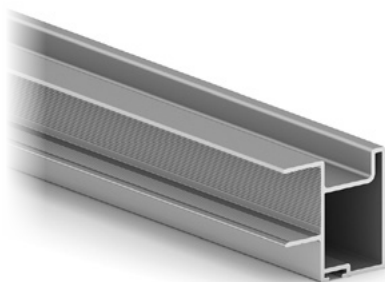

Шифра	Финиш	L	Цена
90286	Елоксиран мат	2.9m	1.269 ден.

5. Н-профил

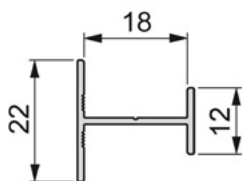
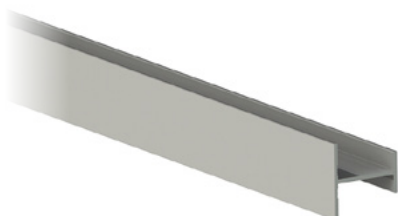

Шифра	Финиш	L	Цена
91777	Елоксиран мат	2.35m	665 ден./ком.
7679	Брусен челик	4m	1.153 ден./ком.

U-профил

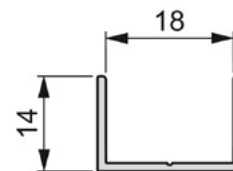

Шифра	Финиш	L	Цена
7726	Елоксиран мат	4m	880 ден./ком.

Четка за шибер

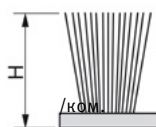

Шифра	H	Самолепливост	Финиш	Цена
7777	7mm	Да	Сив	30 ден./м.
7699	9mm	Да	Сив	35 ден./м.
90923	7mm	/	Сив	20 ден./м.
90836	9mm	/	Сив	25 ден./м.

*Цената се однесува на должен метар

Стабилизатор за врата

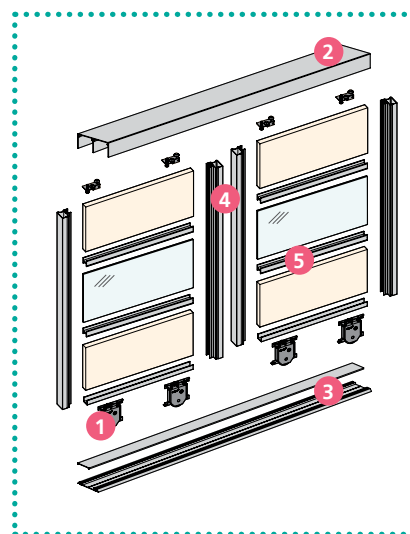
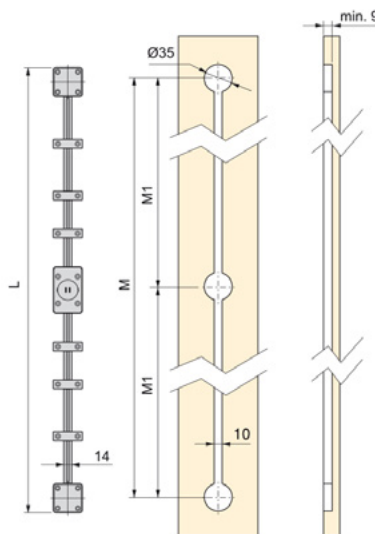
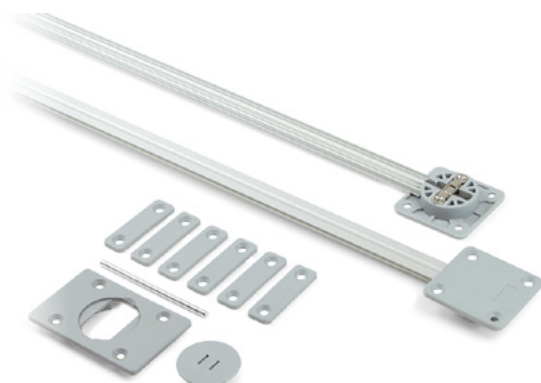

Шифра	L	M	M1	Цена
90929	2290mm	2240mm	1120mm	780 ден.
7678	1970mm	1920mm	960mm	737 ден.

PLACARD 81 за стаклени врати

PLACARD 81 профил 14+4



Шифра	L/m	Цена
90719	2.35	1.604 ден./ком.

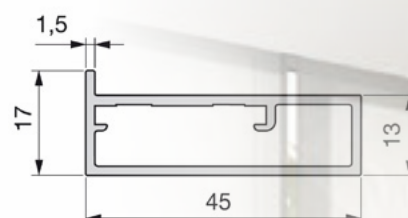

PLACARD 81 сет додатоци за исполна 12+4

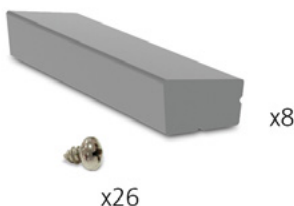

Шифра	Цена
90720	127 ден.



PLACARD 81 L-профил горен/долен



Шифра	L/m	Цена
90722	3.2	683 ден./ком.

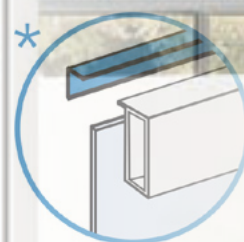
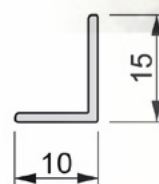

PLACARD 81 трака за стакло



Шифра	L/m	Цена
90721	3	644 ден.

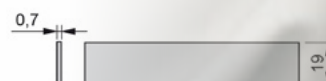



Placard 74

сет за врата со меко затворање

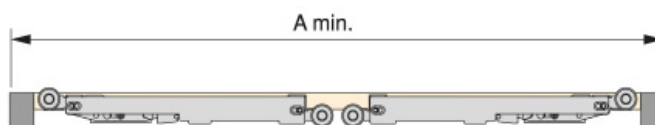

	Wave 18	Sharp 18
A min.	634 mm	634 mm

- За плакари со 2- врати или 3- врати
- Подесување на висината на долните тркалца $\pm 7,5$ mm.
- Безбеден систем - без можност за случајно излегување од шиниите.
- За лесна монтажа на вратата, горните тркалца се закочуваат.
- Меко отворање и затворање за плакари со 2- врати.
- Горната кочница дозволува вратите да се движат во две насоки.

Шифра	Носивост	Цена
90839	30 kg	1.098 ден.
90840	50 kg	1.145 ден.

Placard 74

сет долни тркала за врата со меко затворање



90841 | 351 ден.



Placard 74

сет долни тркала за врата со стопер

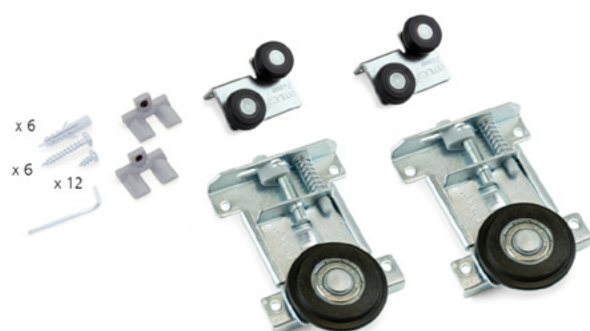

90842 | 729 ден.

Placard 74

Горна шина

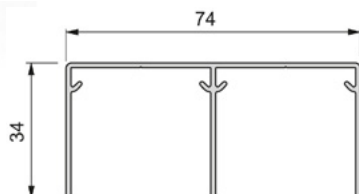
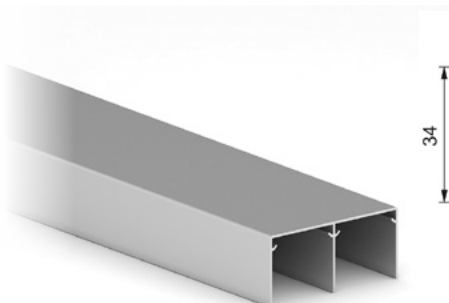

Шифра	Финиш	L	Цена
92279	Бел	2.35m	1.383 ден./ком.
92763	Бел	3.9m	2.755 ден./ком.
91581	Антрацит	2.35m	1.755 ден./ком.
91695	Антрацит	3.5m	2.505 ден./ком.
92804	Црна	2.35m	1.755 ден./ком.
92805	Црна	3.9m	3.045 ден./ком.

Placard 74

Н-профил

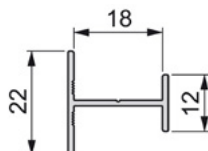
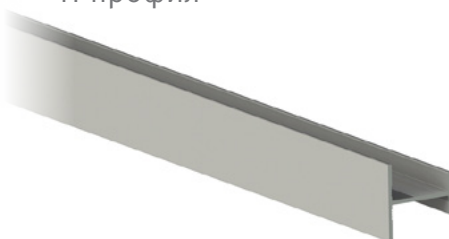

Шифра	Финиш	L	Цена
90845	Антрацит	2.35m	1.436 ден./ком.

Placard 74

Долна шина

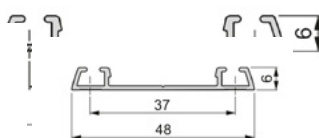

Шифра	Финиш	L	Цена
92281	Бел	2.35m	578 ден./ком.
92764	Бел	3.9m	1.068 ден./ком.
91582	Антрацит	2.35m	610 ден./ком.
92526	Антрацит	3.5m	1.005 ден./ком.
92806	Црна	2.35m	663 ден./ком.
92807	Црна	3.9m	1.095 ден./ком.

Sharp18

рачка

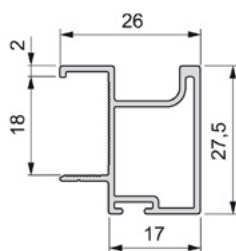
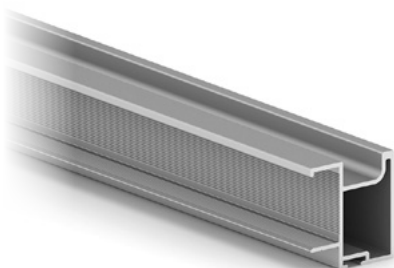

Шифра	Финиш	L	Цена
90936	Бел	2.9m	1.109 ден./ком.
90922	Антрацит	2.9m	1.335 ден./ком.
92808	Црна	2.9m	1.335 ден./ком.

Barn сет систем за врата до 80kg



- Систем за дрвени лизгачки врати, идеален за постигнување на рустична и модернта атмосфера.
- Носивост до 100 kg и дебелина на дрвени врати од 35 до 45 mm
- Во сетот е вклучен профил од 2m, со вклучени 2 стопери, додатоци и завртки за поставување и прицврстување.
- Лесна за монтажа и непречно водење
- Метал, црна боја.

Шифра	Носивост	Цена
92294	80 kg	6.285 ден.





MOKA

wardrobe storage system





PR
DESIGN



emuca 



Лифт оклагија за гардеробер

- ▶ Лифт оклагија за лесен дофат на закачалките од горната зона на гардероберот. Со лифт оклагијата високите делови од гардероберот стануваат лесно достапни. Со регулација на повеќе ширини за лесна адаптација во сите типови на гардеробери.
- ▶ Носивост до 12kg, со споро движење

Дистанцер за лифт оклагија

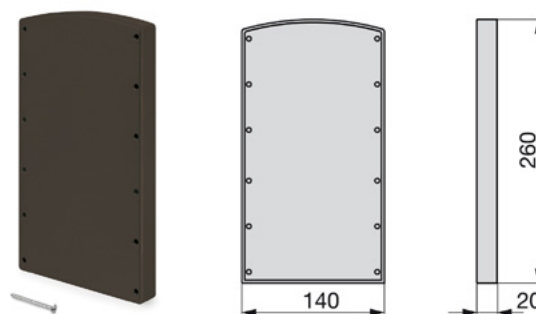

90653 | 250 ден.



Финиш: Алуминиум хром

A= 60 - 83cm | **3.130** ден.
7683

A= 83 - 115cm | **3.130** ден.
7778

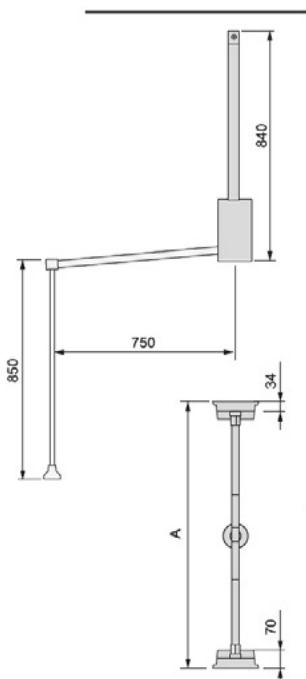

Финиш: Кафена

A= 60 - 83cm | **3.399** ден.
90496

A= 83 - 115cm | **3.759** ден.
7772



SLING лифт за гардеробер

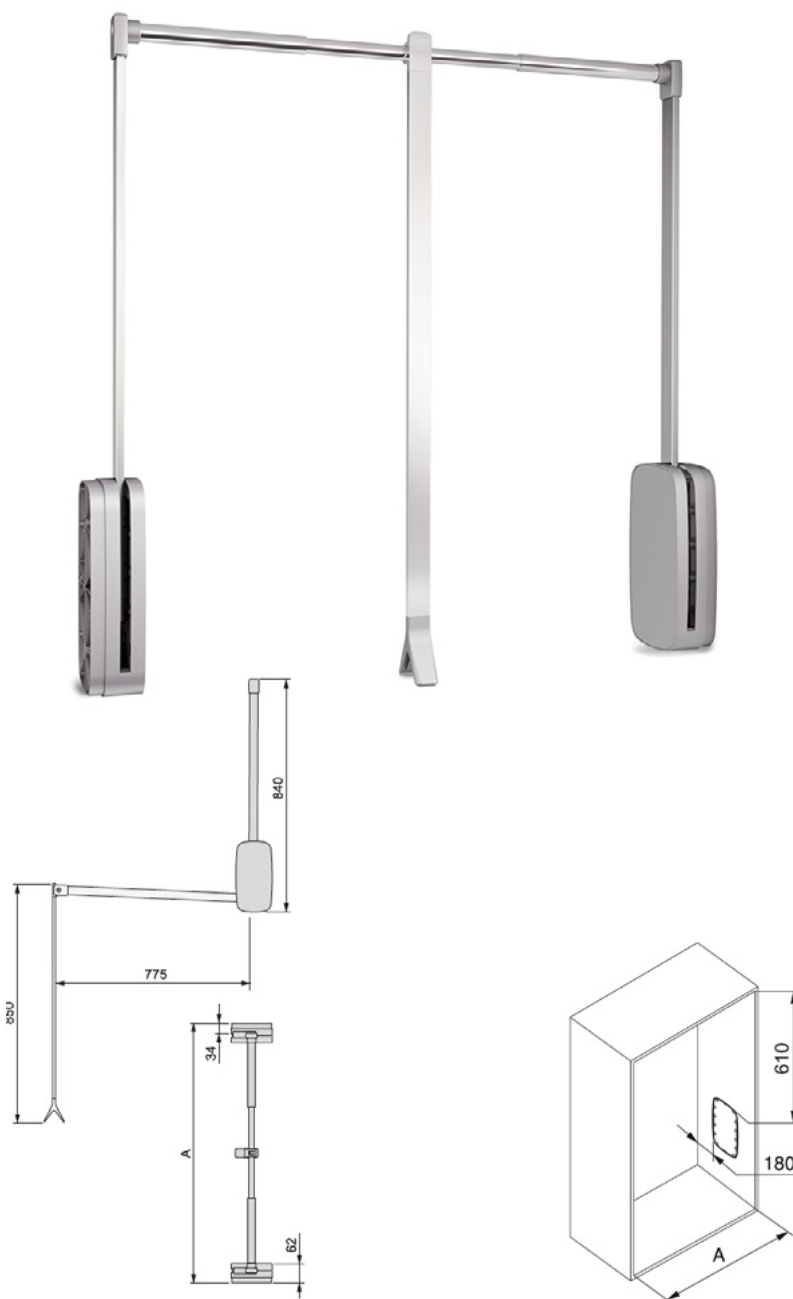

Финиш: Бела

A= 60 - 83cm | **3.559** ден.
91832

A= 83 - 115cm | **3.559** ден.
91833

Финиш: Титаниум

A= 60 - 83cm | **3.695** ден.
92699

A= 83 - 115cm | **3.695** ден.
92700

Сет рамка и водилка

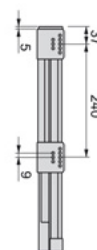
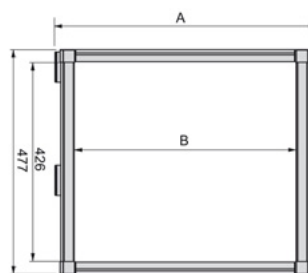
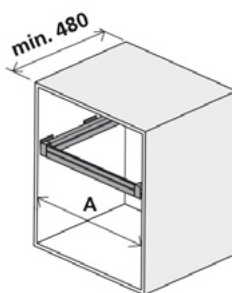

Шифра	A	B	Цена
90497	564-614mm	484-534mm	5.328 ден.
90834	664-714mm	584-634mm	5.924 ден.
90692	764-814mm	684-734mm	6.339 ден.
90835	814-864mm	784-834mm	6.247 ден.
90696	864-914mm	734-784mm	6.377 ден.
90928	964-1014mm	884-934mm	6.659 ден.

Сет рамка и водилка

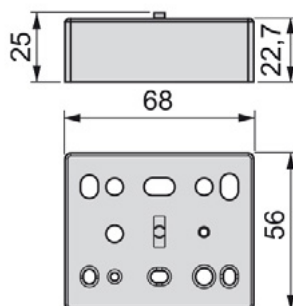

90498 | 199 ден.

Метална корпа за фиока

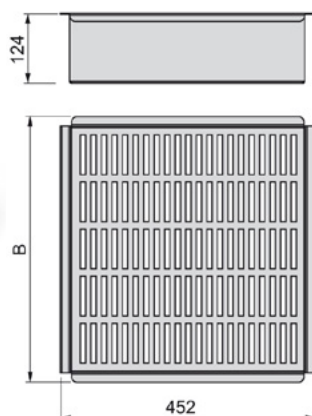

Шифра	B	Цена
90499	481	5.621 ден.
92535	675	6.442 ден.
92155	775	6.678 ден.

Жичена корпа за фиока

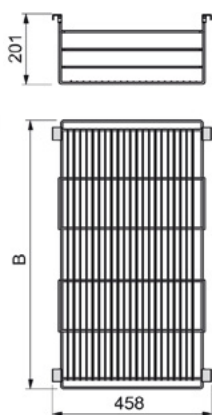

Шифра	В	Цена
90500	475mm	2.219 ден.
92536	675mm	2.875 ден.
90925	775mm	3.062 ден.

Дрвена кутија за фиока

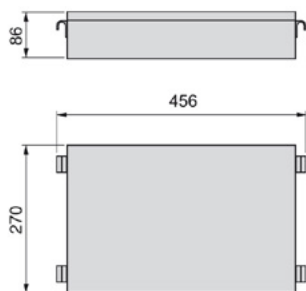

Шифра	Димензија	Цена
90502	270 x 456 x 90mm	6.850 ден.

Дрвена организација за фиока

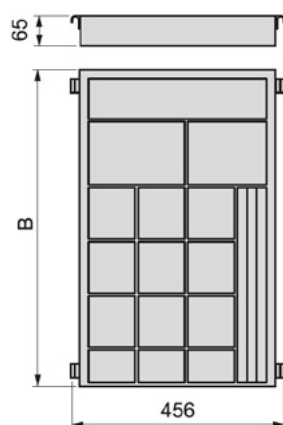

Шифра	В	Цена
90503	481 mm	4.336 ден.
90693	681 mm	6.358 ден.
90715	781 mm	6.989 ден.

Пластична организација за фиока

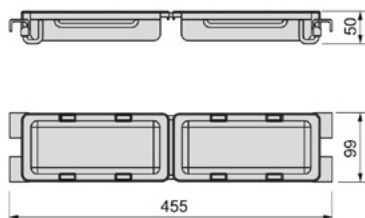

90504 | 1.289 ден.

Платнена корпа за облека

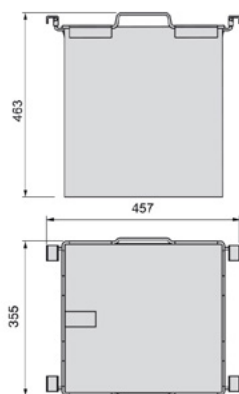

Шифра 90495 | Димензија 385 x 363mm | Цена 2.499 ден.

Сет од 7 држачи за панталони

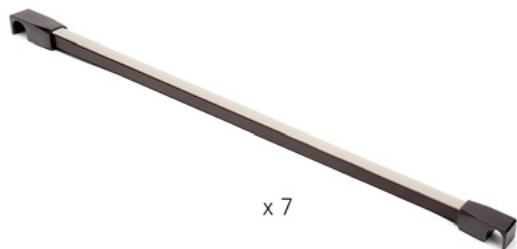
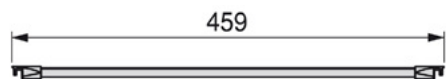

x 7



Шифра 90505 | Димензија 459mm | Цена 1.830 ден.

Држач за оклагија

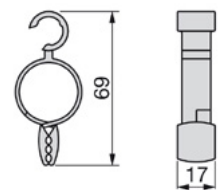

Шифра 90506 | Материјал Пластика | Цена 25 ден.

Закачалка на извлекување со меко затворање

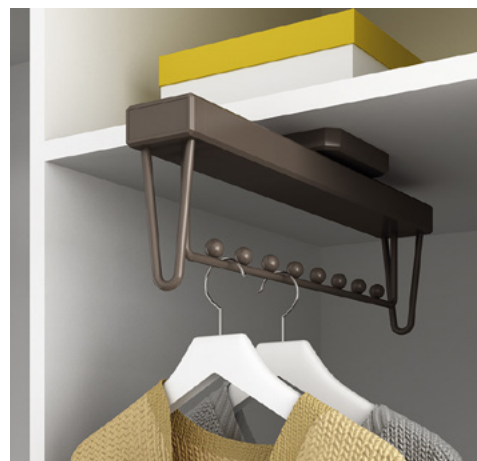
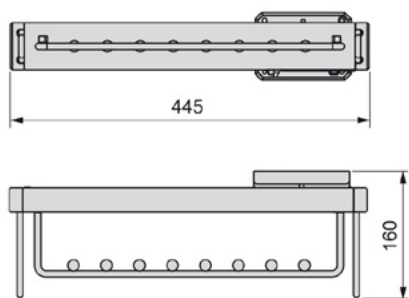

90507 | 3.646 ден.

Закачалка за панталони на извлекување

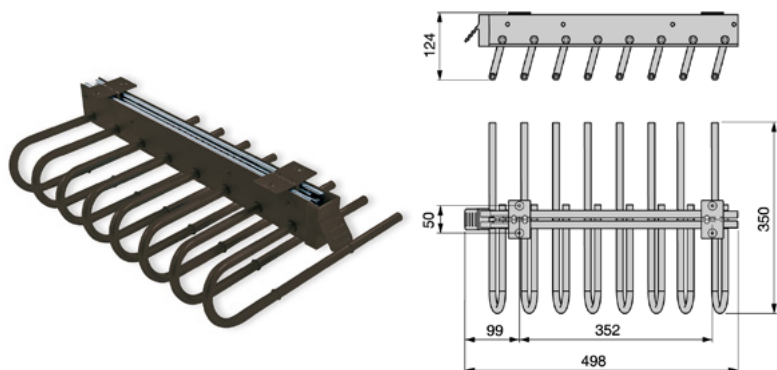

Шифра	Позиција	Цена
91059	Десна	3.385 ден.
91140	Лева	3.385 ден.

Закачалка за кравати со меко затворање

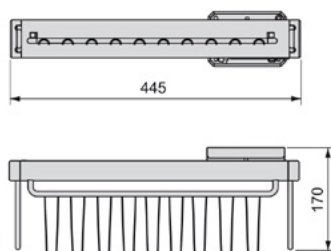

90508 | 3.518 ден.

Огледало на извлекување

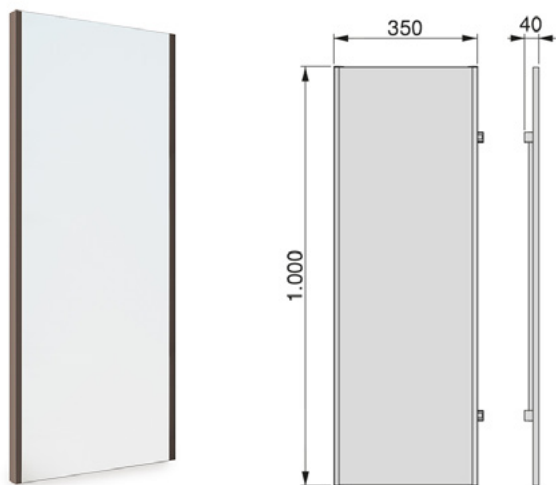

91112 | **6.858** ден.

Огледало на извлекување

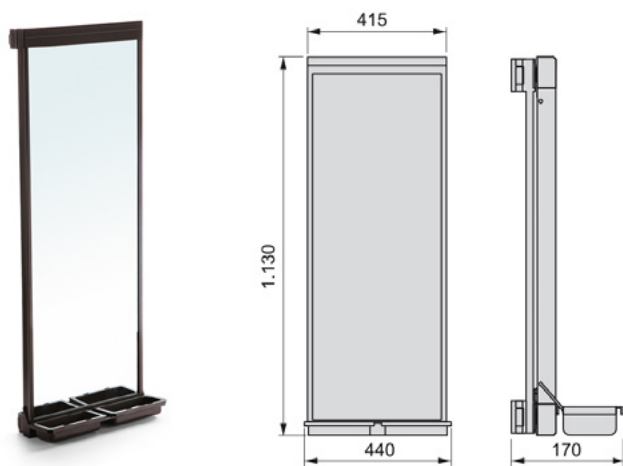

Шифра | Н | Цена
90509 | **1130mm** | **13.052** ден.

Механизам на извлекување за обувки

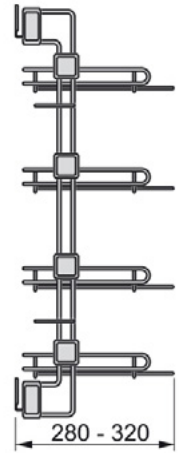
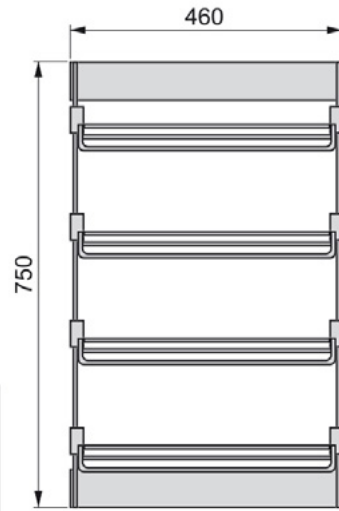
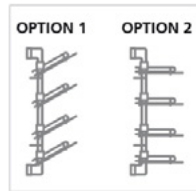

Шифра	Позиција	Цена
90766	Лев	9.357 ден.
90843	Десен	9.358 ден.



Жичена корпа за чевли за фиока

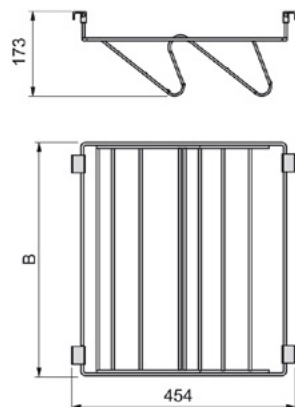
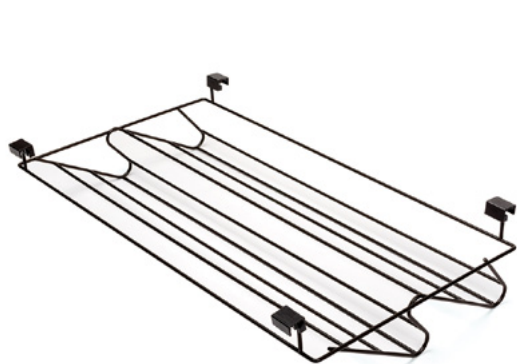

Шифра	В	Цена
90501	475mm	1.922 ден.
90926	775mm	2.171 ден.

Метална корпа за чевли за фиока

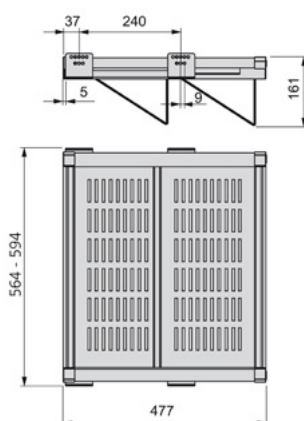

Шифра	Цена
91757	9.745 ден.

Маса за пеглање на извлекување со преклоп



- Маса за пеглање на извлекување со преклоп
- Можност за фиксирање на позиција.
- Водилка со лагери за меко и тивко водење.
- Минимални димензии за внатрешно монтирање : 450mm x 450mm.
- Димензии на површината за пеглање: 810mm x 300mm.

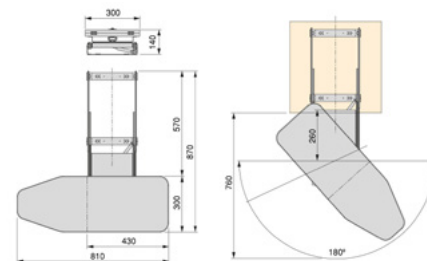

Шифра	Цена
92530	9.275 ден.



CASTOR Лед оклагига со сензор

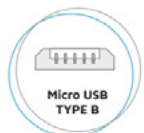

0,25 m	120°	240 lx
0,50 m		100 lx
0,75 m		55 lx
1,00 m		35 lx
1,25 m		25 lx

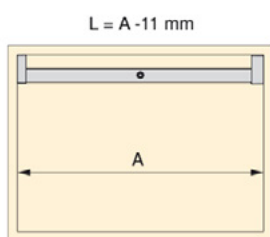

- ▶ Природно бела
- ▶ 4.000K



Шифра	W	L/mm	A/mm	Цена
90931	0.6W	547	558	3.223 ден.
90937	0.9W	847	858	3.688 ден.



Лухе оклагија за гардеробер

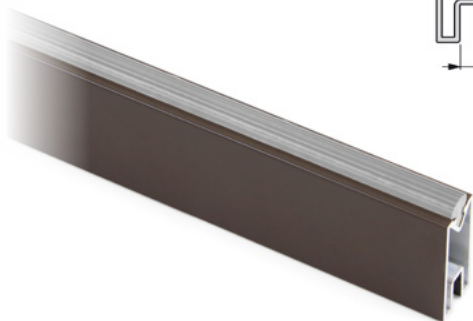
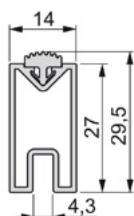

LUXE држач за оклагија

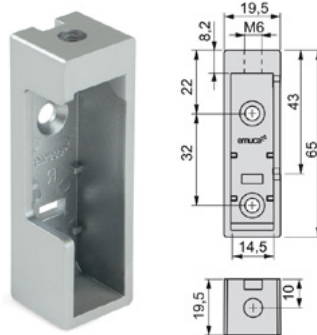

Шифра	Позиција	Цена
91117	Лев	117 ден.
91116	Десен	117 ден.

LUXE држач за оклагија

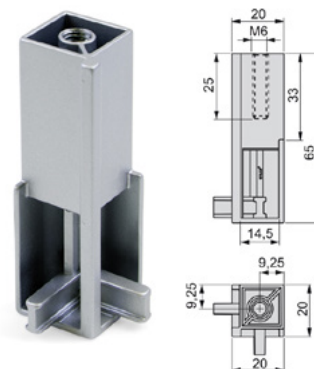

Шифра	Позиција	Цена
91825	аголен	195 ден.

Шифра	L/m	Цена
91057	2,35	1.365 ден./ком.

Оклагија за гардеробер



Држач за оклагија

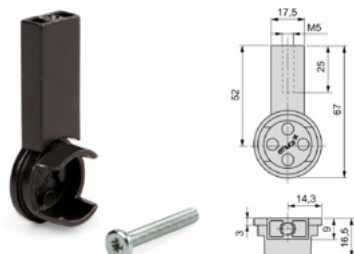

90685	106 ден.
-------	----------

Држач за оклагија



91025	Ø28mm	53 ден.
-------	-------	---------

Среден држач за оклагија

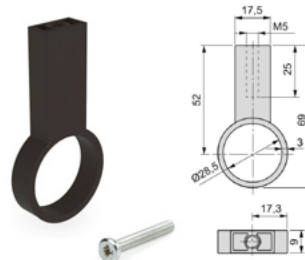

92691	141 ден.
-------	----------

Шифра	Ø	L	Цена
90691	28mm	4m	1.669 ден./ком.





Concepta 25

Системи за лизгачки врати,
собирачки и склопувачки
врати

CONCEPTA 25

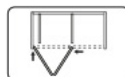
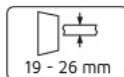

- ▶ Систем за лизгачки, собирачки и склопувачки врати.
- ▶ Можност за монтирање на елементи или помеѓу сидови.
- ▶ Можност за прикривање на простор или работен простор (кујна, перална, канцеларија, соблекувална, итн.)
- ▶ Со отворен систем немате потреба од долна шина, со тоа што добивате максимално пристапен простор.
- ▶ Максимум тежина на врата: 25 kg = 50 kg/set.
- ▶ Ширина на врата: 300 to 700 mm.
- ▶ Висина на врата: 1851 to 2600 mm.
- ▶ Дебелина на врата: 19 to 26 mm.
- ▶ Можност за подесување вертикално, хоризонтално и во косина
- ▶ Комплетот содржи оков доволно за две врати
- ▶ Системот може да се монтира за лева или десна страна.
- ▶ Елоксиран сребрен мат финиш.
- ▶ LGA сертификат.

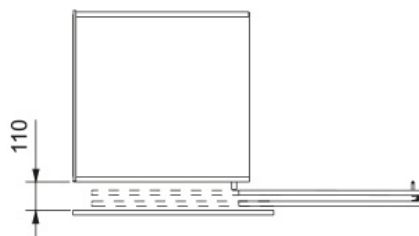
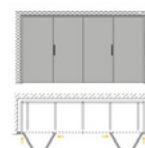
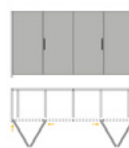
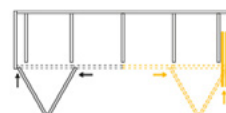
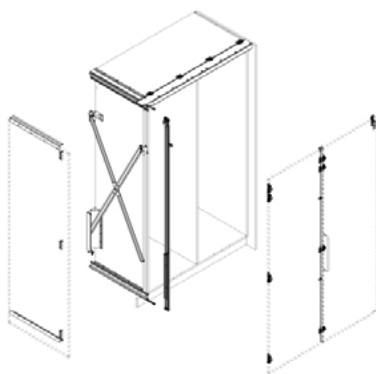
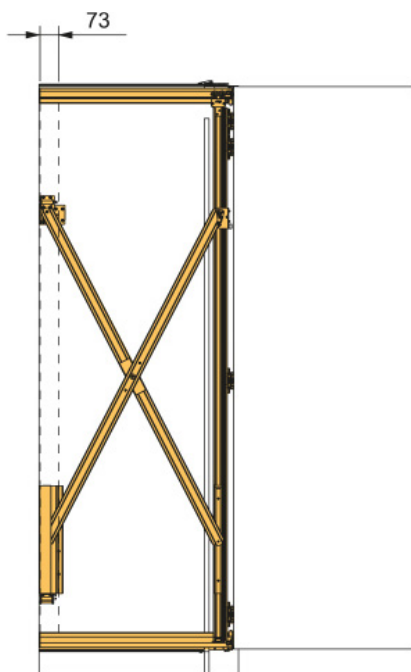

Шифра	Опис	Финиш	Цена
90604	Сет за врата со преклоп ЛЕВ	Елоксиран мат	155.640 ден.
90605	Сет за врата со преклоп ДЕСЕН	Елоксиран мат	155.640 ден.
90607	Сет за врата	/	3.723 ден.
90608	Сет профил со плочка 2.6m	Елоксиран мат	22.165 ден.

CONCEPTA 25 Сет за долен профил

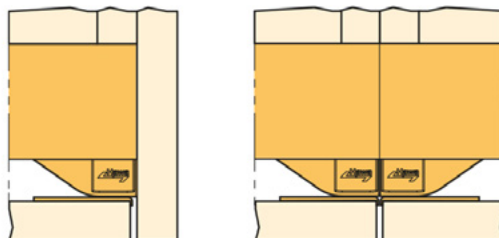

Шифра	Финиш	L	Цена
90606	Елоксиран мат	1.3m	12.280 ден.

CONCEPTA 25 Сет за врата

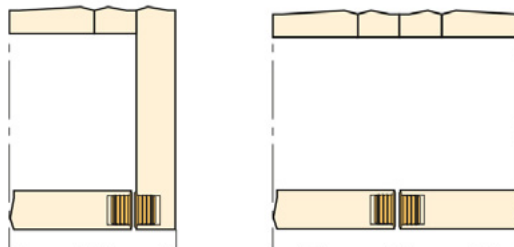
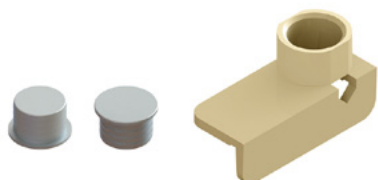

90607			3.723 ден.
-------	--	--	------------

CONCEPTA 25 Сет профил со плочка

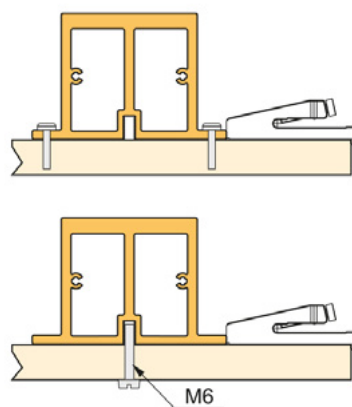
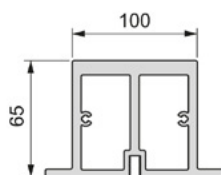

Шифра	Финиш	L	Цена
90608	Елоксиран мат	2.6m	22.165 ден.

TUBOSILK Оклагија

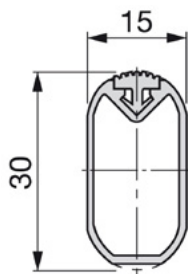

Шифра	Финиш	L/m	Цена
7749	Алуминиум мат	2.4	769 ден./ком.

TUBO Оклагија

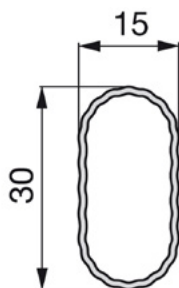

Шифра	Финиш	L/m	Цена
7719	Алуминиум мат	2.4	455 ден./ком.

TUBO Оклагија

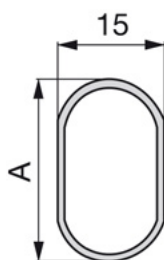

Шифра	Финиш	A/mm	L/m	Цена
92200	Хром	30	2.35	298 ден./м.

*Цената се однесува на должен метар

Оклагија за гардеробер

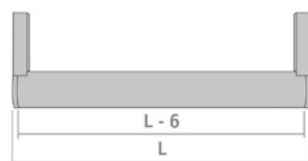
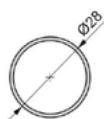

Држач за оклагија

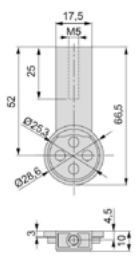

92693	257 ден.
-------	----------

Шифра	Ø/mm	L/m	Финиш	Цена
92692	28	2.35	титаниум	998 ден./ком.

Оклагија за гардеробер



Кружен држач за оклагија



92749 | Ø28mm | 45 ден.

Сет држачи за оклагија

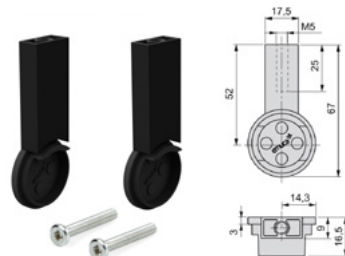

92748 | 214 ден.

Шифра	Ø/mm	L/m	Финиш	Цена
92747	28	2.35	Црн	889 ден./ком.

SILK2 Аголен држач за оклагија

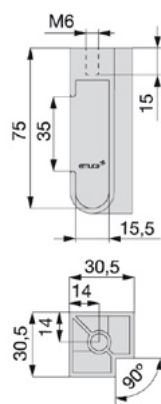

Шифра	Финиш	Цена
7677	Сребрен	85 ден.

SILK2 Сет држачи за оклагија

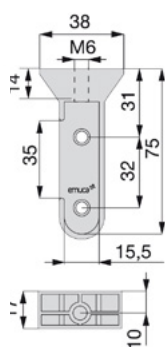

Шифра	Финиш	Цена
92701	Сребрен	115 ден.
92810	Црн	119 ден.

SILK2 Држач за оклагија



Шифра	Финиш	Позиција	Цена
7692	Сребрен	Лев	55 ден.
7775	Сребрен	Десен	55 ден.

SILK2 Среден држач за оклагија

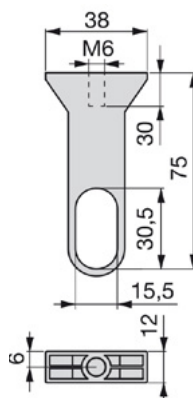

Шифра	Финиш	Цена
7728	Сребрен	60 ден.

TUBOSILK Држач за оклагија

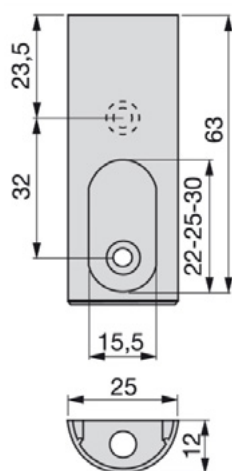

Шифра	Финиш	Цена
7739	Сребрен	51 ден.

TUBOSILK Среден држач за оклагија

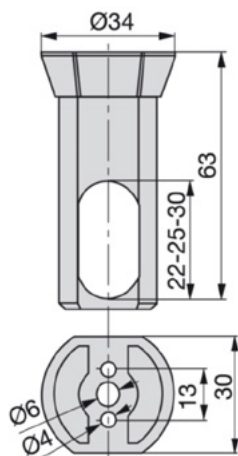

Шифра	Финиш	Цена
7731	Алуминиум мат	63 ден.

Среден држач за оклагија

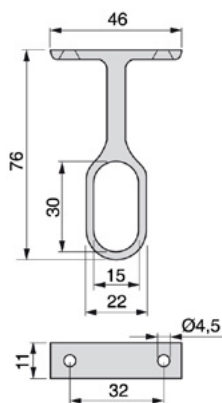

Шифра	Финиш	Цена
748	Алуминиум мат	69 ден.
768	Хром	59 ден.

Држач за оклагија

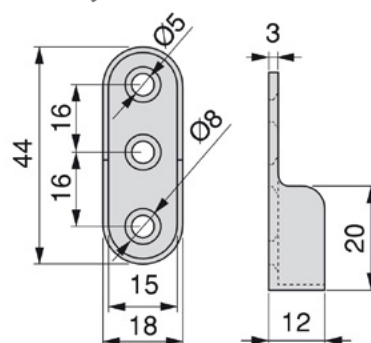

Шифра	Финиш	Цена
350	Хром	12 ден.

Закачалка на извлекување

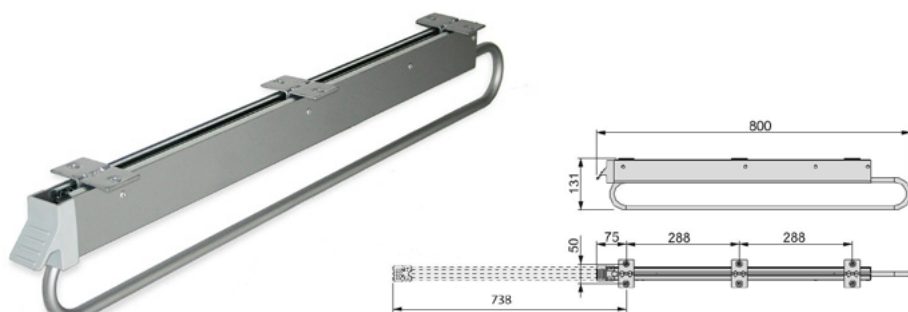

Шифра | Финиш | L | Цена
92811 | **Сребрен** | **800** | **2.878** ден.



Оклагија на извлекување

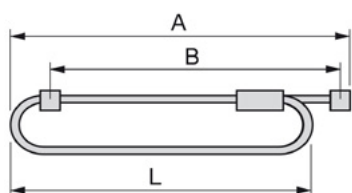

L	B	A
300	302	335
350	352	385
400	402	435
450	452	485



Шифра | Финиш | L | Цена
7737 | **Сребрен** | **300** | **565** ден.
7709 | **Сребрен** | **350** | **688** ден.
7743 | **Сребрен** | **400** | **725** ден.
7682 | **Сребрен** | **450** | **755** ден.



emusa 



Завршни лајсни и цокли

PLASLINE задна лајсна

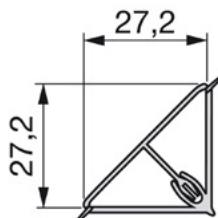

Шифра	Финиш	L	Цена
7752	Алуминиум сатен	4m	1.393 ден./ком.

PLASLINE капачиња



7723	Сиви	89 ден.
------	------	---------

PLASLINE цокле

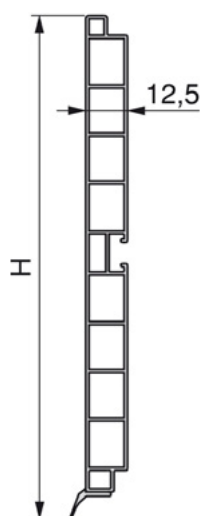

Шифра	H/mm	L	Финиш	Цена
7742	100	3,9m	Алуминиум сатен	330 ден./м.
7746	100	4m	Брусен челик	345 ден./м.
7959	100	4m	Антрацит	329 ден./м.
7974	100	3,9m	Бел	387 ден./м.
91763	100	2,35m	Антрацит	850 ден./ком.

Шифра	H/mm	L	Финиш	Цена
7710	150	4m	Алуминиум сатен	326 ден./м.
90009	150	4m	Брусен челик	495 ден./м.
91751	150	2,35m	Антрацит	954 ден./ком.

*Цената се однесува на должен метар

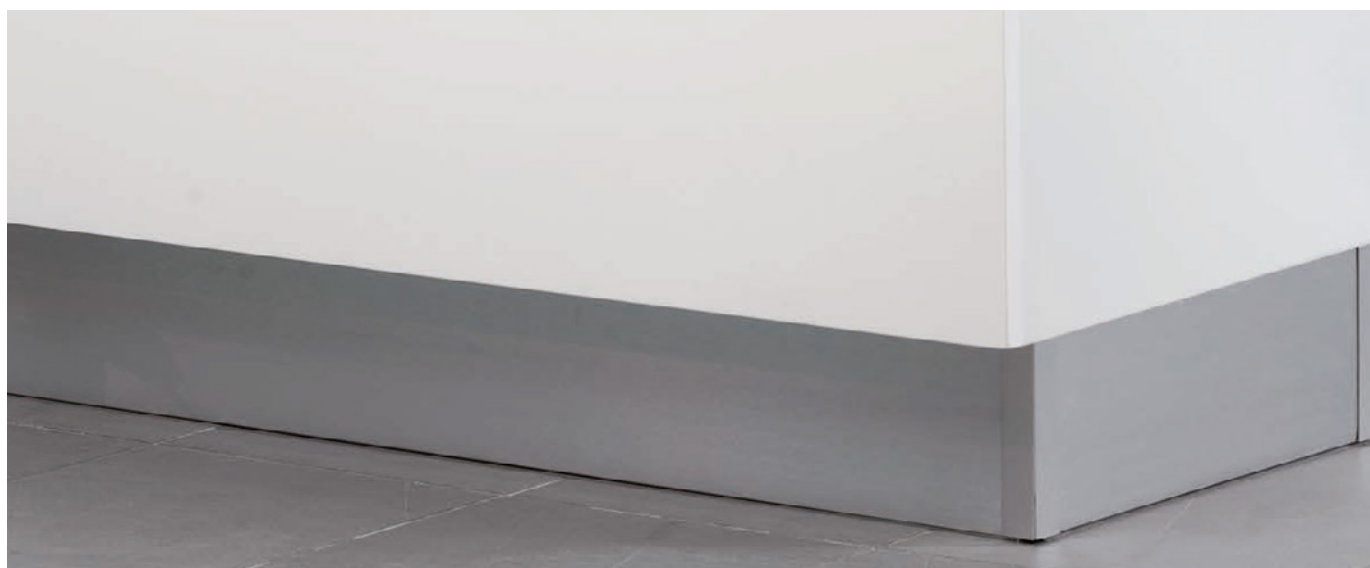

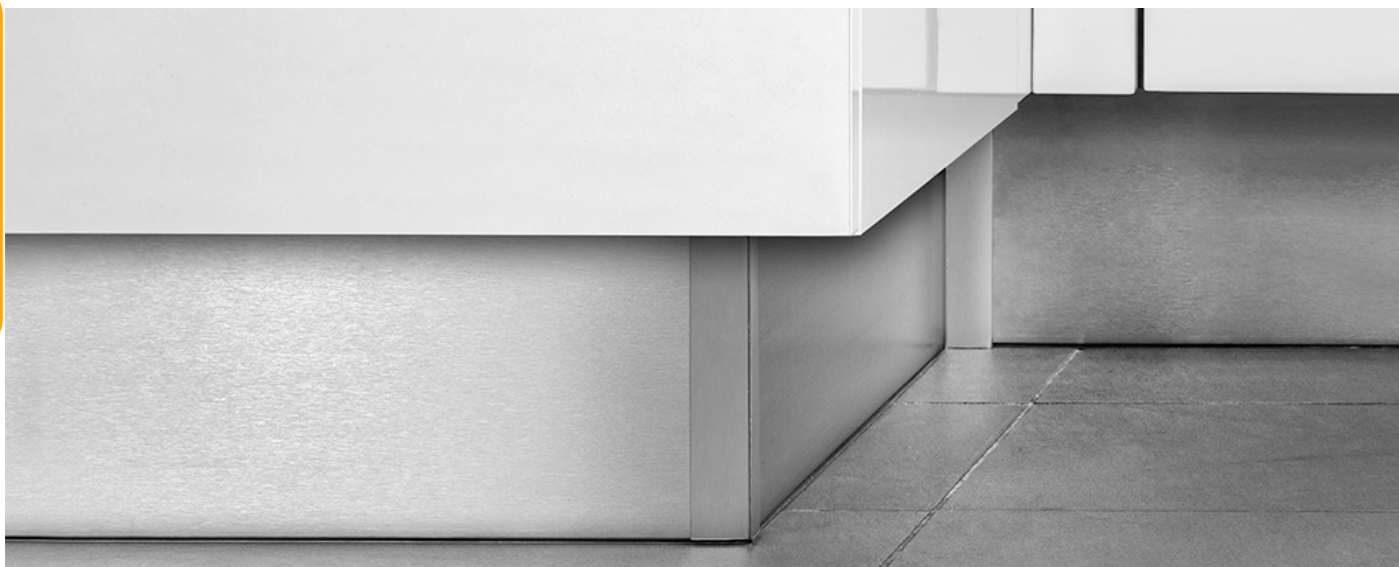

PLASLINE флексибилен аголник за цокле

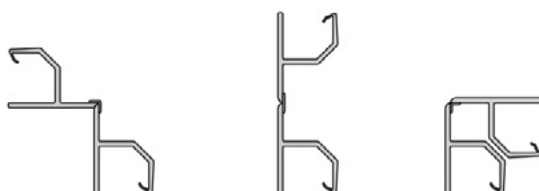
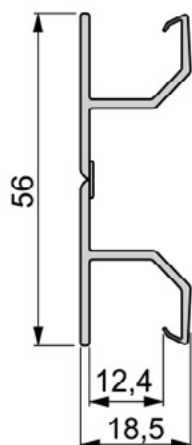

Шифра	Финиш	Н/мм	Цена
90136	Алуминиум сатен	100	111 ден./ком.
90137	Брусен челик	100	115 ден./ком.
90135	Бел	100	111 ден./ком.
91755	Антрацит	100	111 ден./ком.
91756	Антрацит	150	138 ден./ком.

Аголник за цокла 90° аголник

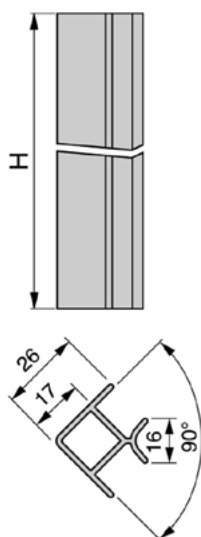

Шифра	Финиш	Н/мм	Цена
7757	Алуминиум сатен	100	79 ден./ком.
7975	Брусен челик	100	89 ден./ком.
90019	Антрацит	100	85 ден./ком.
90134	Алуминиум сатен	150	102 ден./ком.
90133	Брусен челик	150	118 ден./ком.

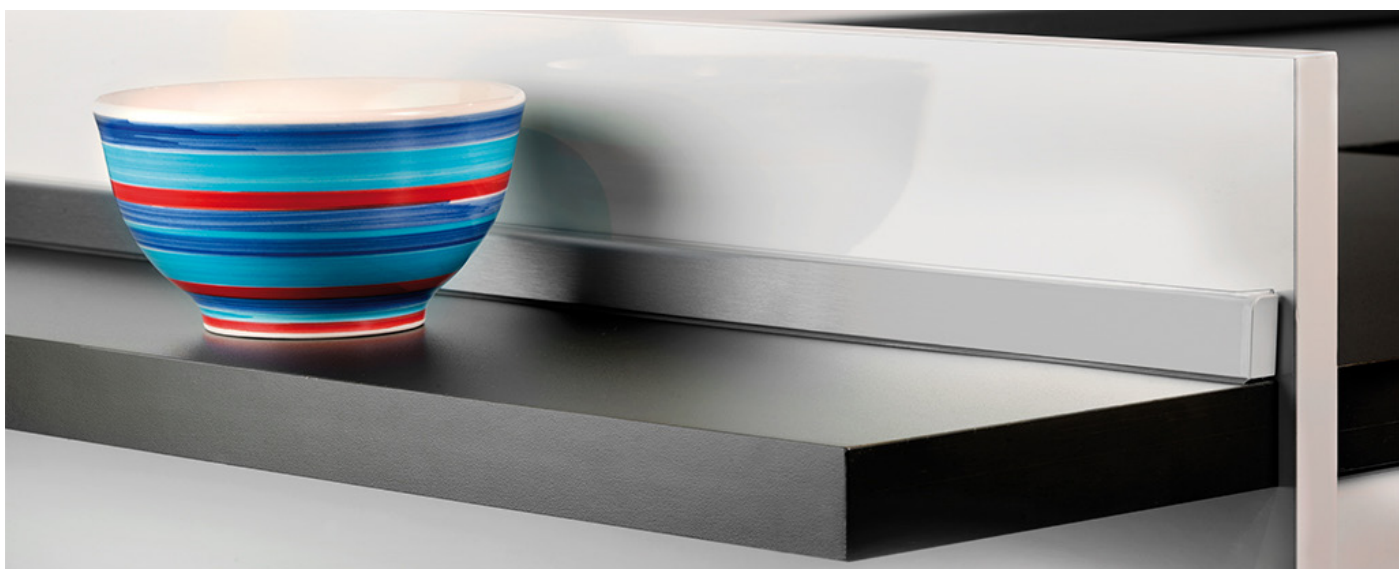

MINILINE завршна лајсна

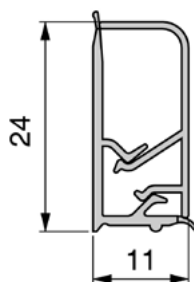

Шифра	Финиш	L/m	Цена
7676	Алуминиум сатен	4	1.292 ден./ком.
90686	Антрацит	4	1.458 ден./ком.

MINILINE сет капачиња



7694	Сив	85 ден.
90738	Антрацит	89 ден.

MIXLINE завршна лајсна

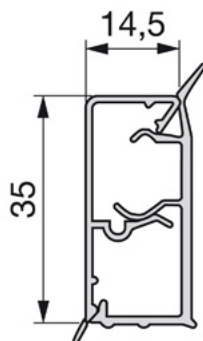

Шифра	Финиш	L/m	Цена
7761	Алуминиум сатен	4	1.980 ден./ком.
7745	Бел	4	1.970 ден./ком.

MIXLINE сет капачиња



7764	Сив	85 ден.
7685	Бел	77 ден.

emusa 

Гола профили

GOLA-L профил рамка

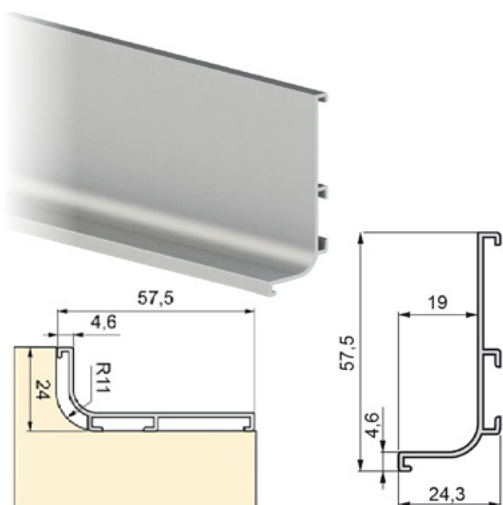

Gola-L сет капачиња



Шифра	Финиш	Цена ден.
91055	Антрацит	405 ден.
91108	Сив	413 ден.
91109	Шампањ	403 ден.

Шифра	Финиш	L/m	Цена ден./ком.
4450	Елоксиран мат	4	1.863 ден./ком.
90130	Антрацит	3,9	2.215 ден./ком.
90288	Шампањ	4	2.475 ден./ком.
90020	Бел	3,9	1.865 ден./ком.

GOLA-C профил рамка

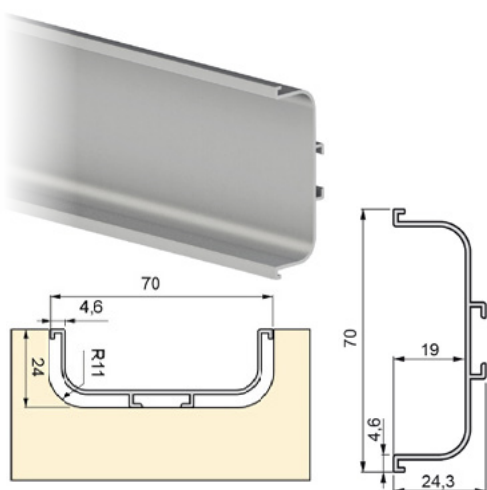

Gola-C сет капачиња



Шифра	Финиш	Цена ден.
91056	Антрацит	405 ден.
91110	Сив	401 ден.
91111	Шампањ	401 ден.

Шифра	Финиш	L/m	Цена ден./ком.
4443	Елоксиран мат	3,9	2.231 ден./ком.
91752	Антрацит	2,35	1.515 ден./ком.
90129	Антрацит	3,9	2.685 ден./ком.
91754	Шампањ	2,35	1.707 ден./ком.
90308	Шампањ	4	2.838 ден./ком.
91753	Бел	2,35	1.248 ден./ком.
90021	Бел	3,9	2.079 ден./ком.

GOLA-E вертикален среден профил

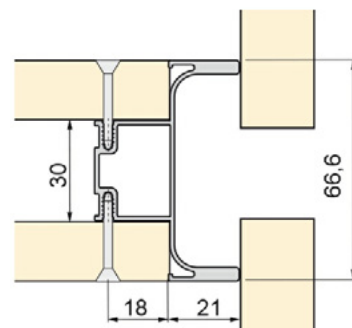
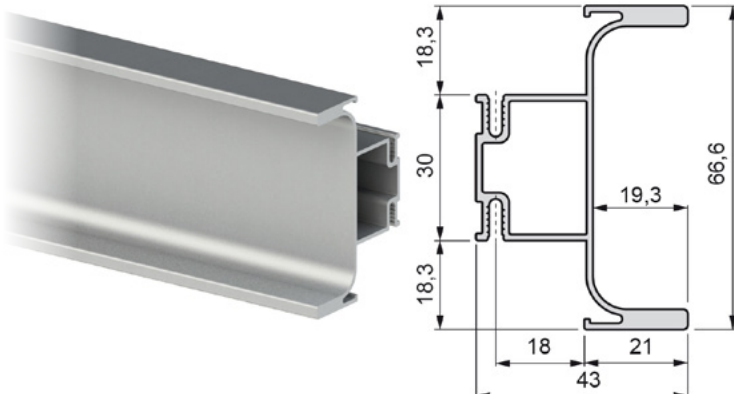

Шифра	Финиш	L/m	Цена ден./ком.
7973	Елоксиран мат	2,55	2.540 ден./ком.
91137	Антрацит	2,35	3.174 ден./ком.
90154	Антрацит	2,55	2.978 ден./ком.
90289	Шампањ	2,55	3.690 ден./ком.
90684	Бел	2,55	2.937 ден./ком.

GOLA-E краен вертикален профил

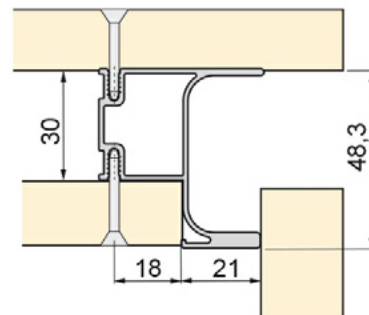
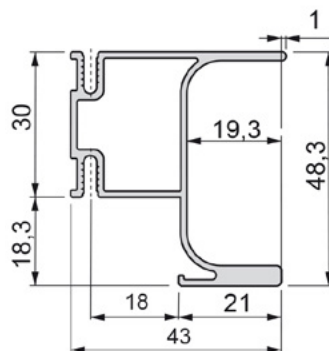
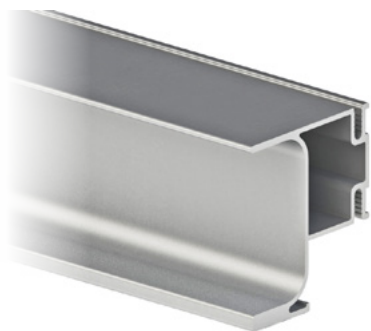

Шифра	Финиш	L/m	Цена
7978	Елоксиран мат	2.55	2.363 ден./ком.
90153	Антрацит	2.55	3.029 ден./ком.
90514	Шампањ	2.55	2.957 ден./ком.
90654	Бел	2.55	2.523 ден./ком.

GOLA-TOP профил

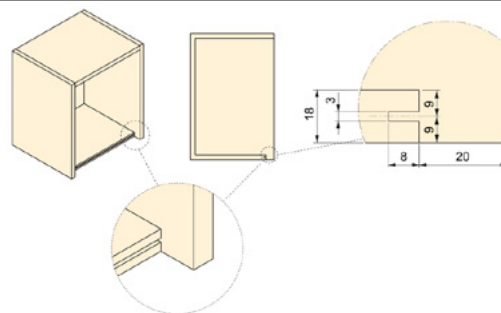
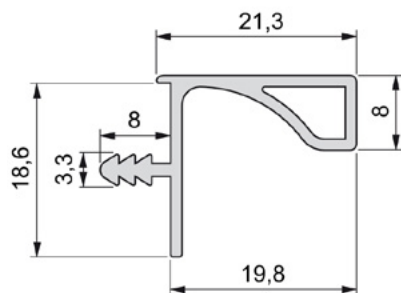

Шифра	Финиш	L/m	Цена
92751	Елоксиран мат	2.35	1.060 ден./ком.
90131	Елоксиран мат	3	1.295 ден./ком.
90132	Антрацит	3	1.653 ден./ком.
90515	Шампањ	3	1.645 ден./ком.

GOLA-E профил за фурна

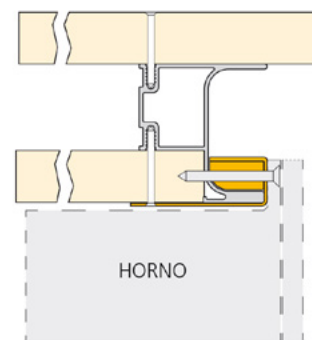
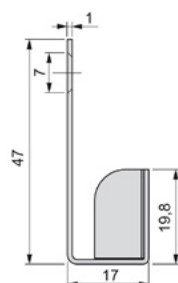

Шифра	Финиш	L/mm	Цена
90290	Елоксиран мат	580	1.003 ден.
90291	Антрацит	580	1.253 ден.
90520	Шампањ	580	2.715 ден.

GOLA-TOP профил за 19mm

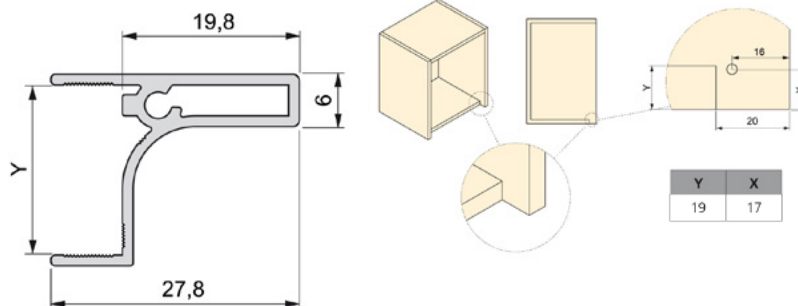
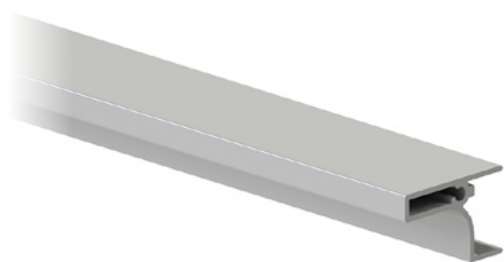

Шифра | Финиш | L/м | Цена

90655 | Бел | 3 | 1.510 ден./ком.

Држач за GOLA метален

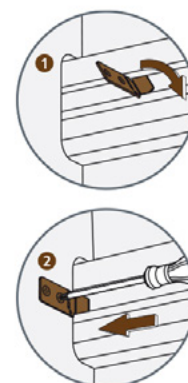
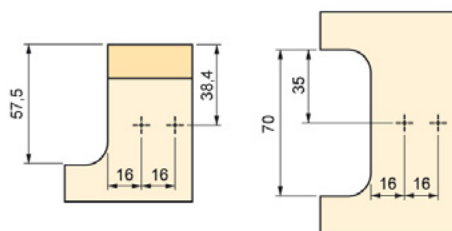

4425 | 35 ден.

Држач со штраф за GOLA метален

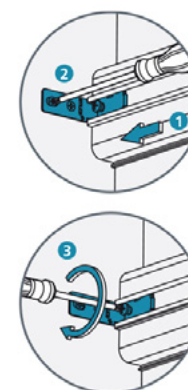
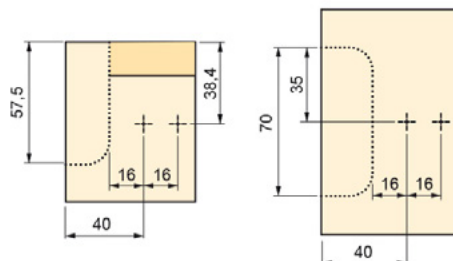

7979 | 70 ден.

emuca 



Кујнски Системи



Supra механизам за аголен елемент

- Систем дизајниран за лесна достапност на задниот дел од аголниот елемент со правоаголна форма.
- Систем за складирање со 4 корпи со меко затворање.
- Носивост 4x5kg или вкупно до 20kg
- Минимални димензии на елементот за вградвање 505x864mm
- Минимална ширина на вратата од 400mm

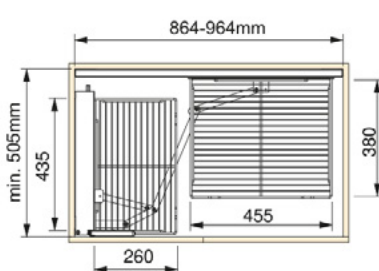
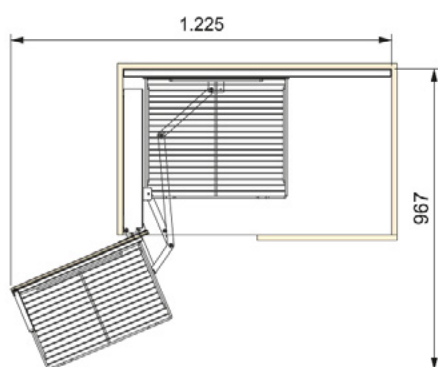
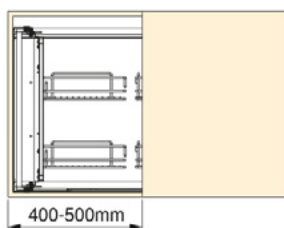
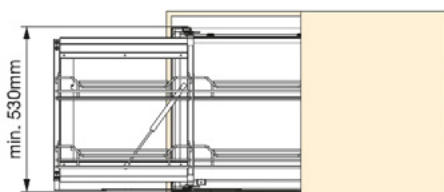

7969

23.870 ден.



SHELVO 3/4

Систем за аголен елемент

- 3/4 Кружни полици кои ротираат на осовина,
- Наменети за аголни елементи со минимална димензија 800x800mm
- Се подесува на различни висини.
- Носивост до 2x20kg или вкупно 40kg
- Изработена е од материјал високоотпорен на механички удари, UV зраци, и не создава електрицитет при триење со друг тип на материјали.

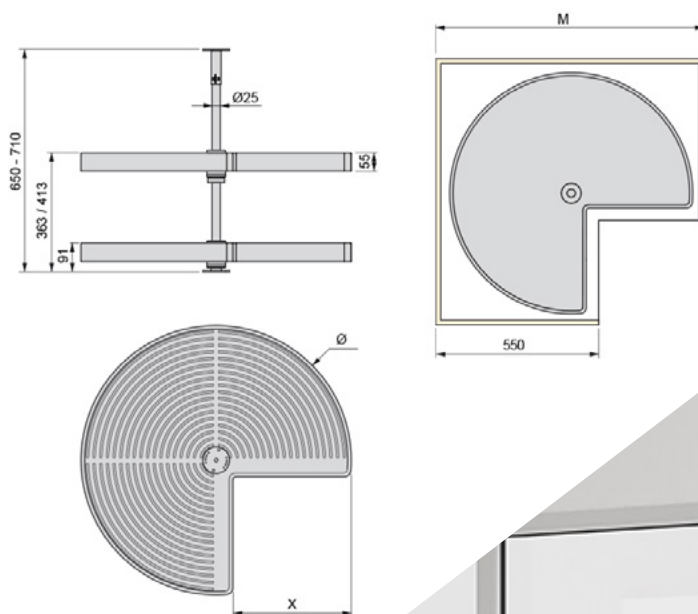

90022

5.014 ден.



Алуминиумска заштита за под садопер

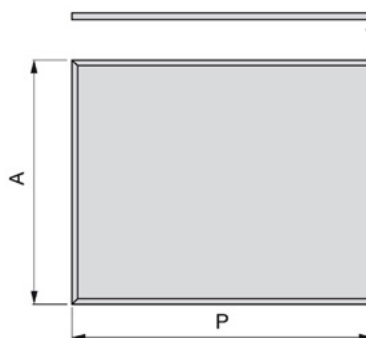

Шифра	Димензија	Финиш	Цена
7696	600 / 18 x 510	Сребрен	435 ден.
7755	900 / 18 x 510	Сребрен	595 ден.
7684	1200 / 18 x 510	Сребрен	669 ден.

Base Frigo

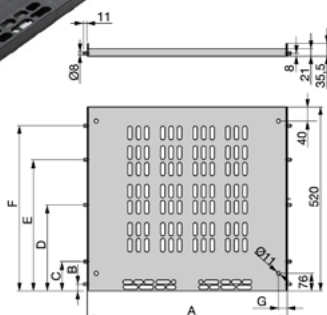

- За фрижидери со должина од 60 см.
- Модел: за 16mm и 18mm
- Основата е перфорирана за вентилација на фрижидерот.

7708 | 995 ден.

Решетка за фура

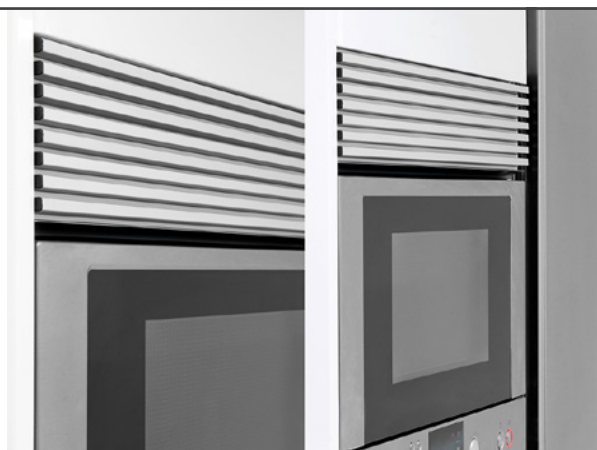
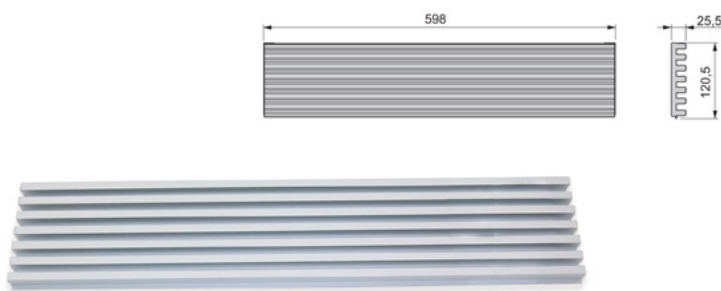

Шифра	Финиш	Цена
90138	Елоксиран мат	1.285 ден.

Држач за чинии 187-208mm

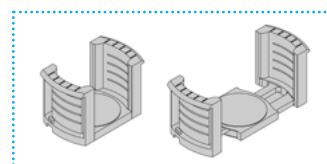
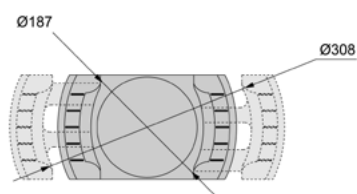
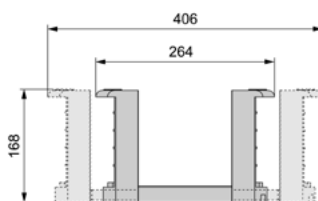

Шифра

90325

Финиш

Сив

Цена

1.810 ден.

Држач за чинии

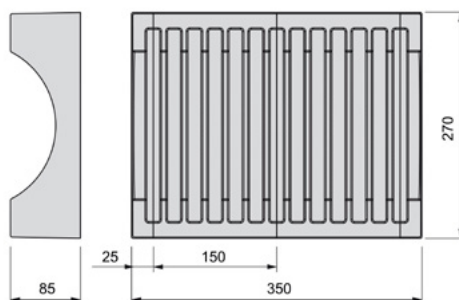

Шифра

92067

Димензии

350 x 270mm

Финиш

Антрацит

Цена

2.593 ден.

Магнетен држач за ножеви



• Можност за вертикално или хоризонтално позиционирање.

• Лесна монтажа со самолеплива лента

• Димензија:

Должина 400 mm,
Ширина 40 mm,
Дебелина 15 mm

• Вграден магнет, нерѓосувачки челик

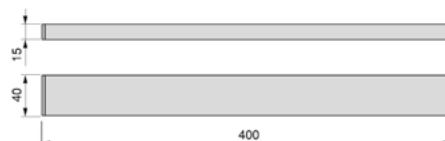

Шифра

92755

Цена

1.677 ден.

Монтажа со самолеплива лента од задната страна





Организатор за чинии

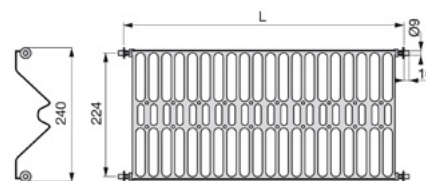

Шифра	L	Цена
90739	735-770mm	2.314 ден.
92198	535 - 570mm	2.419 ден.

Закачалка на извлекување за крпи 310mm

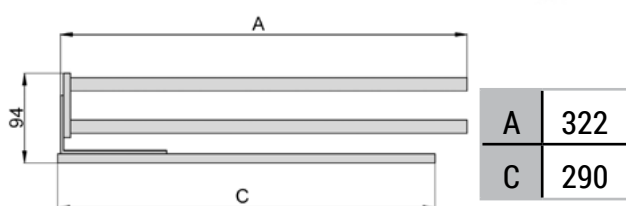

Шифра	Финиш	Цена
90752	Алуминиум мат	1.340 ден.

Закачалка за метла и џогер

5 закачалки и 4 држачи

• 5 закачалки и 4 места за закачување на метли и џогери со држачи кои се адаптираат на дебелината на рачката.

• Димензии:
Должина: 330mm,
Ширина: 62mm,
Дебелина: 83mm

• Пластика, сива.

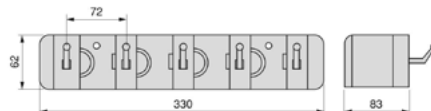

Шифра	Цена
92756	1.143 ден.



SUPRA држач за чаши

1 x 280mm

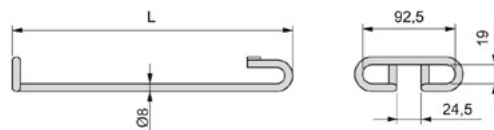

Шифра	Димензија	Финиш	Цена
91761	1 x 280mm	хром	645 ден.

4 x 280mm

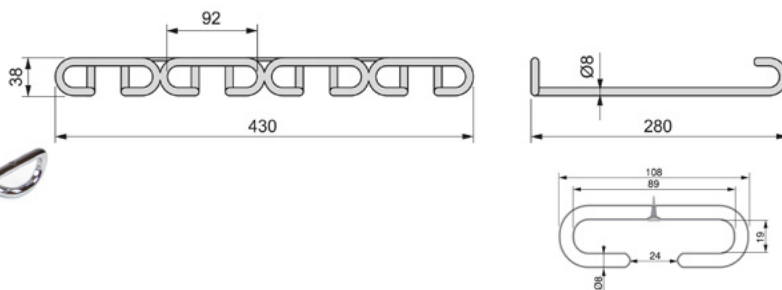

Шифра	Димензија	Финиш	Цена
92403	4 x 280mm	хром	2.067 ден.

1 x 370mm

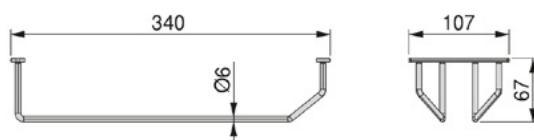

Шифра	L	Цена
91758	1 x 370mm	379 ден.

5 x 450mm

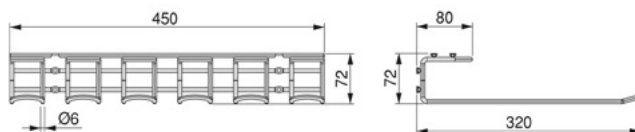

Шифра	L	Цена
91759	5x450mm	1.359 ден.



SUPRA држач за шишиња

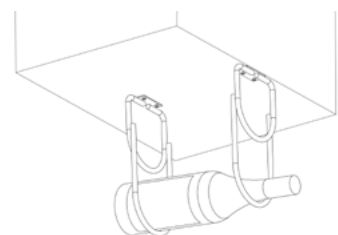
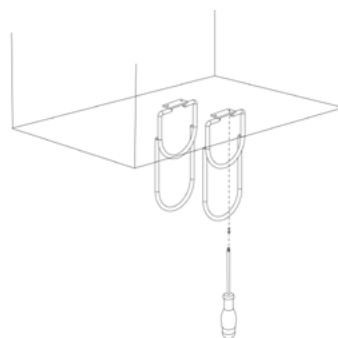
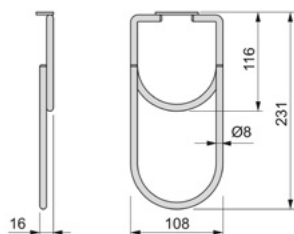

Шифра | Димензија | Финиш | Цена
92402 | **108x231** | **хром** | **1.029** ден.

SUPRA држач за шишиња

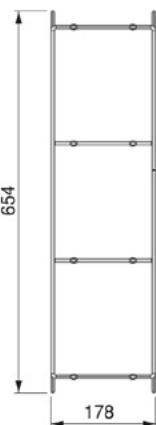
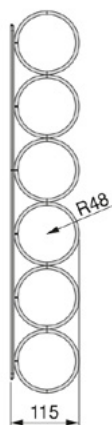

Шифра | L | Цена
91760 | **670x190mm** | **1.540** ден.

SUPRA закачалка 8 L=380mm



91765 | **373** ден.

SUPRA закачалка 5 L=330mm

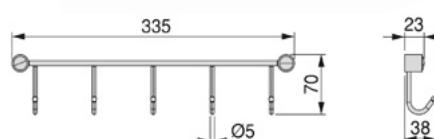

91766 | **595** ден.

SUPRA M15

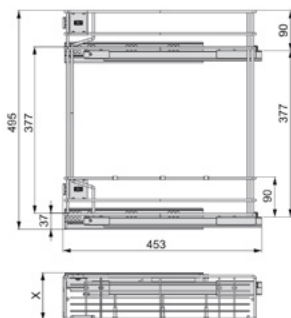

X | 108mm

- За елемент 15 см
- Корпа за шишиња со целосно извлекување
- Со корпи на две висини
- Со меко затворање
- Носивост 2x12,5kg ли вкупно 25kg
- Ширина 108mm
- Монтажа само на лева страна

7729 | 2.905 ден.

SUPRA M20

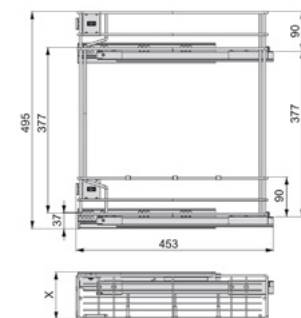

X | 158mm

- За елемент 20 см
- Корпа за шишиња со целосно извлекување
- Со корпи на две висини
- Со меко затворање
- Носивост 2x12,5kg ли вкупно 25kg
- Ширина 158mm
- Монтажа само на лева страна

2780 | 3.355 ден.

TITANE M15

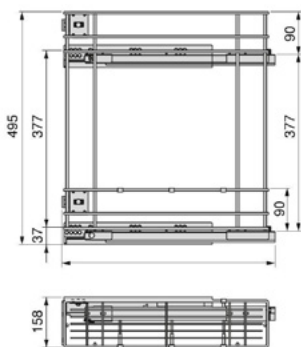

- За елемент 15 см
- Корпа за шишиња со целосно извлекување
- Со корпи на две висини
- Со меко затворање
- Носивост 25kg
- 5D Подесување
- Антрацит финиш

92562 | 3.482 ден.

TITANE M20

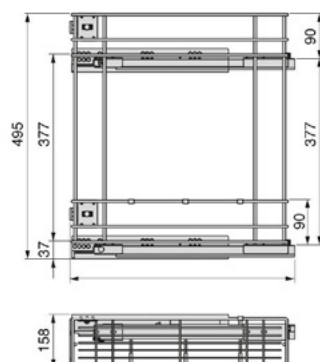

- За елемент 15 см
- Корпа за шишиња со целосно извлекување
- Со корпи на две висини
- Со меко затворање
- Носивост 25kg
- 5D Подесување
- Антрацит финиш

92561 | 3.793 ден.

Канта за отпадоци М30 - 1 x 20 l.

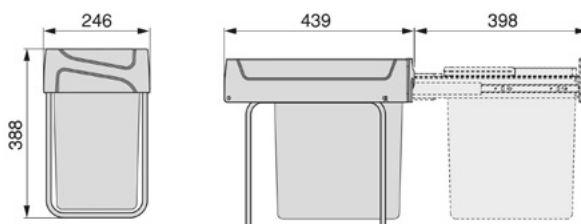

Шифра	Финиш	Цена
92075	Антрацит	2.677 ден.

Канта за отпадоци М40 - 2 x 15 l.

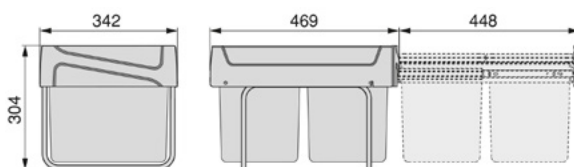

Шифра	Финиш	Цена
92077	Антрацит	3.050 ден.

Канта за отпадоци М40 - 2 x 20 l.

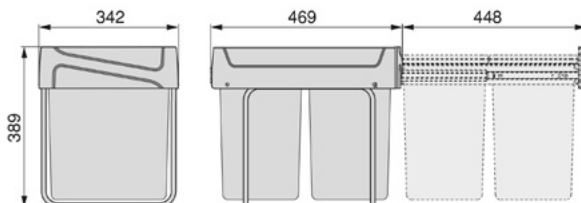

Шифра	Финиш	Цена
92076	Антрацит	3.418 ден.

Канта за отпадоци 1 x 15l



Шифра	Финиш	Цена
90158	Антрацит	1.118 ден.

Канта за отпадоци сет за фиока

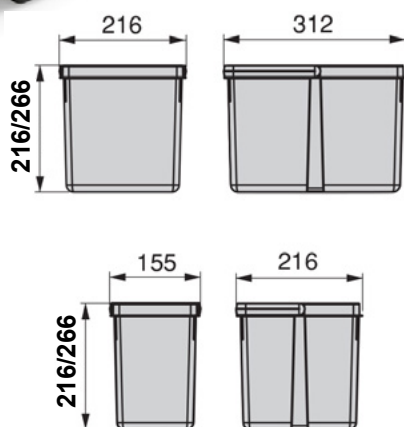
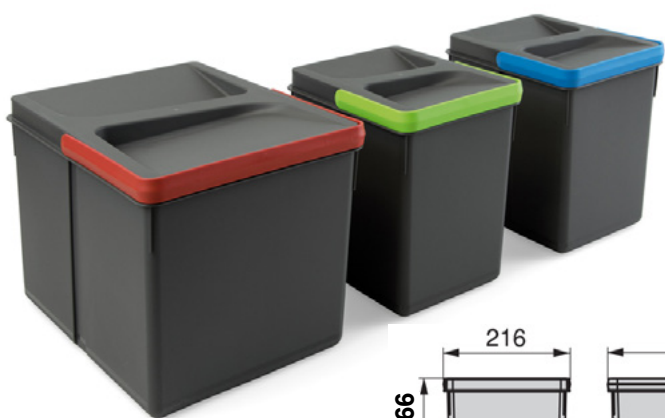

Шифра	H/mm	сет	Цена
90156	216	2x 12l	1.663 ден.
92527	266	2x 15l	1.685 ден.
92290	216	2x 12l + 2x 6l	2.640 ден.
92289	266	2x 15l + 2x 7l	2.754 ден.

База за канта М60

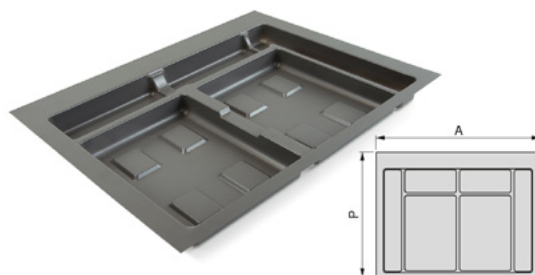

Шифра	A/mm	P/mm	Финиш	Цена
90157	536	482	Антрацит	1.452 ден.
92287	736	482	Антрацит	1.885 ден.
92288	836	482	Антрацит	1.965 ден.



Канта за отпадоци

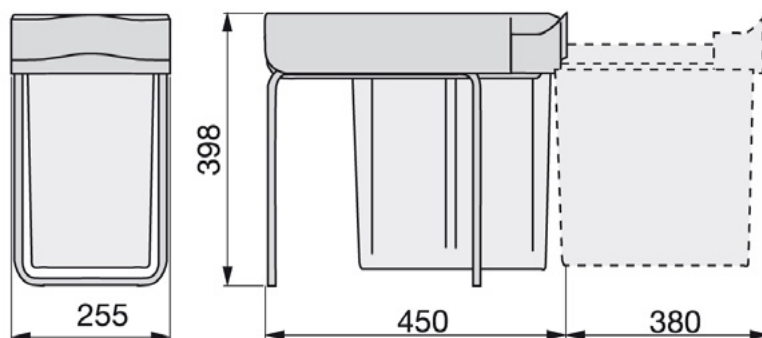

- Капацитет: 2x 14l
- Рачно извлекување
- Капакот се отвора автоматски.

7862 | **2.970** ден.

- Капацитет: 20l
- Рачно извлекување
- Капакот се отвора автоматски.

7892 | **2.932** ден.

Канта за отпадоци

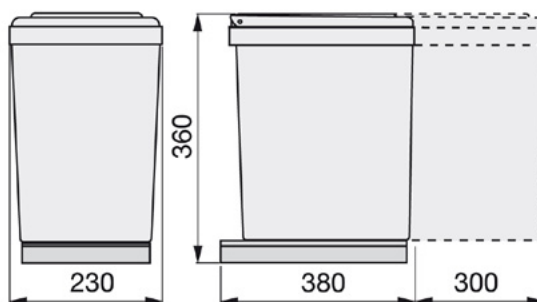

- Капацитет: 16l
- Рачно извлекување
- Капакот се отвора автоматски.

90010 | **2.895** ден.

Канта за отпадоци

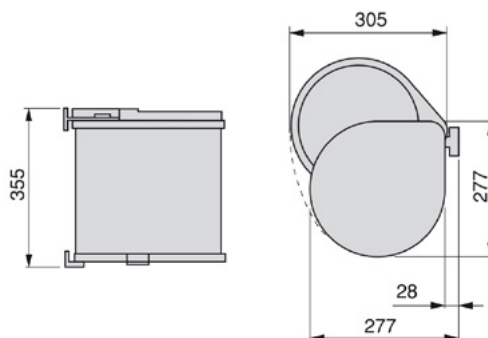

- Капацитет: 13l

Шифра

7861 |

7915 |

Финиш

Бел

Сив

Цена

999 ден.

1.085 ден.

Канта за отпадоци за работни плочи

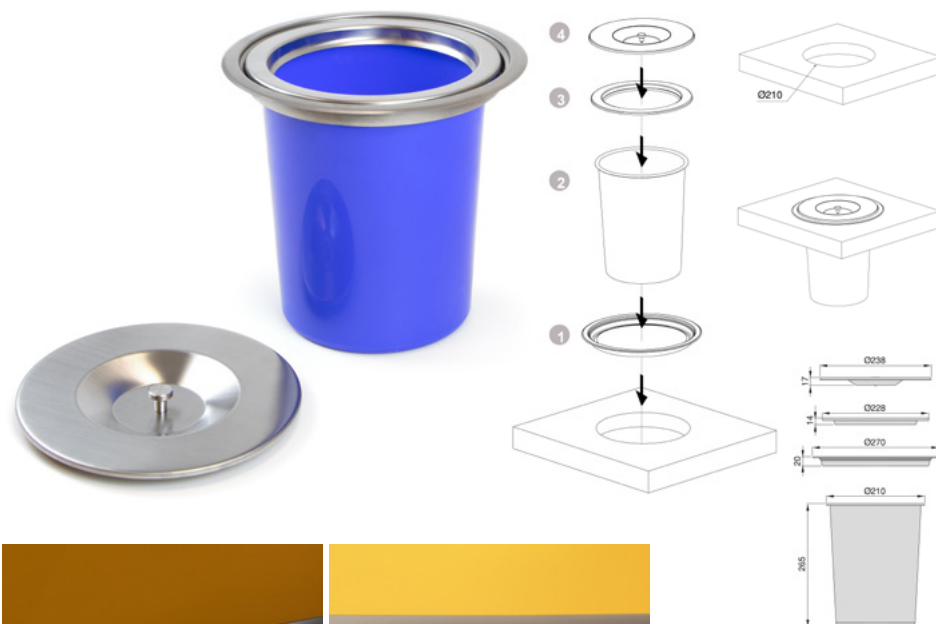

- ▶ Канта за отпадоци за кујна со капаче и капацитет од 8l.
- ▶ Висина: 265mm
- ▶ Дијаметарот на надворешниот прстен: Ø270mm. Се монтира во дупка со дијаметар од Ø210mm
- ▶ Помошни прстени за држење на ќесата.
- ▶ Сина пластика и метални прстени

92531 | 1.880 ден.



emuca 



Рачки

MALI Рачка за мебел

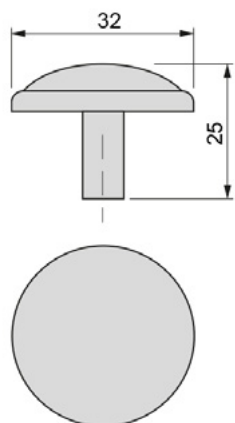

Шифра	С/мм	Материјал	Финиш	Цена
90067	о	Замак	Бронзена	47 ден.
90688	о	Замак	Црна	58 ден.

MARRAKECH Рачка за мебел

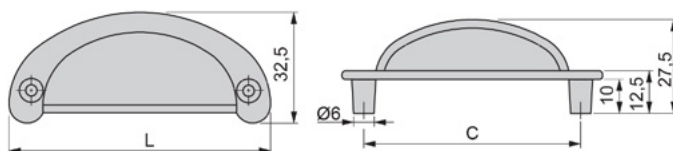

Шифра	С/мм	L/мм	Материјал	Финиш	Цена
90068	64	77	Замак	Бронзена	90 ден.
90069	64	77	Замак	Црна	153 ден.

PAPUA Рачка за мебел

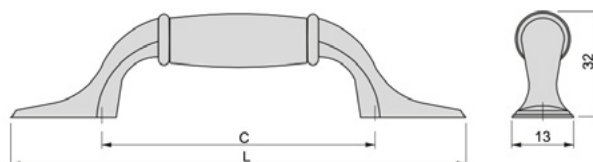

Шифра	С/мм	L/мм	Материјал	Финиш	Цена
90066	76	127	Замак	Старо Сребро	155 ден.
90767	76	127	Замак	Бронза	155 ден.

NAIROBI Рачка за мебел

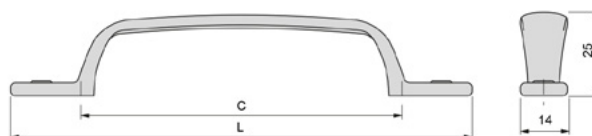

Шифра	С/мм	L/мм	Материјал	Финиш	Цена
90689	96	139	Замак	Бронза	99 ден.

ORLANDO Рачка за мебел

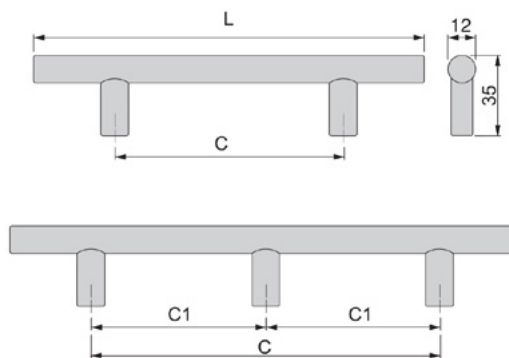

РАЧКИ

Шифра	C/mm	L/mm	Материјал	Финиш	Цена
90314	128	188	Челик	Никел сатен	145 ден.
90315	160	210	Челик	Никел сатен	189 ден.
90316	192	252	Челик	Никел сатен	191 ден.
90317	224	274	Челик	Никел сатен	205 ден.
90318	320	400	Челик	Никел сатен	238 ден.
90319	384	400	Челик	Никел сатен	315 ден.

TUCSON Рачка за мебел

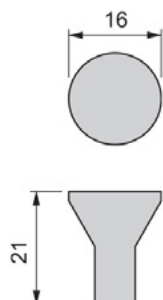

Шифра	Ø/mm	Материјал	Финиш	Цена
90320	16	Замак	Никел сатен	49 ден.
90747	16	Замак	Алуминиум мат	55 ден.

FUJI Рачка за мебел

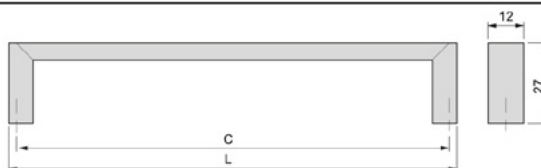

Шифра	C/mm	L/mm	Материјал	Финиш	Цена
90321	96	103	Замак	Алуминиум мат	116 ден.
90322	128	135	Замак	Алуминиум мат	153 ден.
90323	160	168	Замак	Алуминиум мат	196 ден.

MONTEVIDEO Рачка за мебел

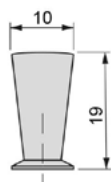

Шифра	Ø/mm	Материјал	Финиш	Цена
92078	10	Месинг	Никел сатен	64 ден.

OREGON Рачка за мебел

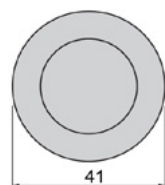
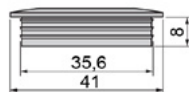

Шифра	Ø/mm	Материјал	Финиш	Цена
90163	35	Замак	Мока	94 ден.
90164	35	Замак	Никел сатен	125 ден.

AUSTIN Рачка за мебел

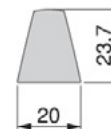
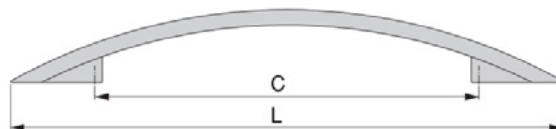

Шифра	C/mm	L/mm	Материјал	Финиш	Цена
90768	128	184	Алуминиум	Хром мат	155 ден.
90513	128	184	Алуминиум	Никел сатен	155 ден.

COIMBRA Рачка за мебел

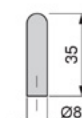
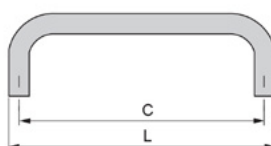

Шифра	C/mm	L/mm	Материјал	Финиш	Цена
91113	96	104	Челик	Хром мат	70 ден.
91114	128	136	Челик	Хром мат	81 ден.

SIENA Рачка за мебел

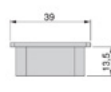
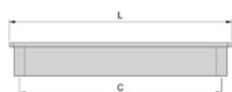

Шифра	C/mm	L/mm	Материјал	Финиш	Цена
91139	96	107	Замак	Хром мат	269 ден.
91141	96	107	Замак	Никел Сатен	275 ден.

emuca 



Осветлување

PRO 
DESIGN

emuca 

Ви ја
претставуваме
најновата
колекција на
ЛЕД светла од
Emuca.

emuca.com
emuca.it • emuca.co.uk • emuca.es • emuca.fr • emuca.pt

LYNX LED лента 4,8W/м IP20

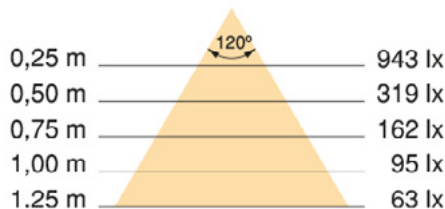

* Цената се однесува на должен метар

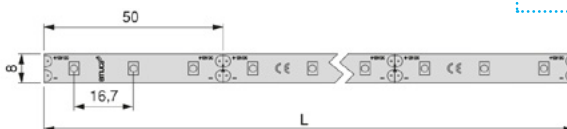

6 W 7080920 15 W 7001420 30 W 7001320 50 W 5008420 72 W 5008520	MOTION SWITCH 5915020 SWITCH 5914120 DIMMER 5008720	SWITCH DOOR 7001520 DOOR 7001720 MOTION 7001820 METAL 7001920	DIMMER SWITCH 5053125 SWITCH 5007125 MOTION 5007025	90744 Ладно бела, 6.000 K 289 ден.
				90997 Топло бела, 3.000 K 298 ден.

LYNX LED лента 4,8W/м IP65

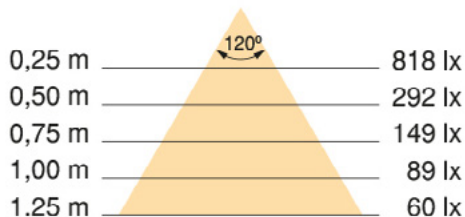

* Цената се однесува на должен метар

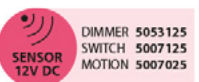
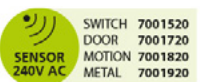
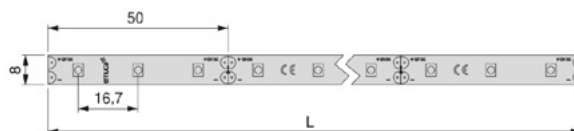

6 W 7080920 15 W 7001420 30 W 7001320 50 W 5008420 72 W 5008520	MOTION SWITCH 5915020 SWITCH 5914120 DIMMER 5008720	SWITCH DOOR 7001520 DOOR 7001720 MOTION 7001820 METAL 7001920	DIMMER SWITCH 5053125 SWITCH 5007125 MOTION 5007025	90745 Ладно бела, 6.000 K 469 ден.
---	---	--	---	--

LYNX LED лента 9,6W/м IP20

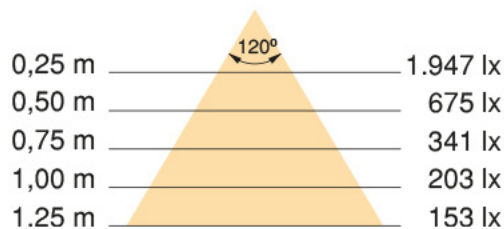

- Самолеплива лед лента со ладно бела и топло бела светлина.
- Одлична намена има за скриено осветлување, кое се рефлектира од ѕидните површини и површините на мебел
- 9,6 W/m

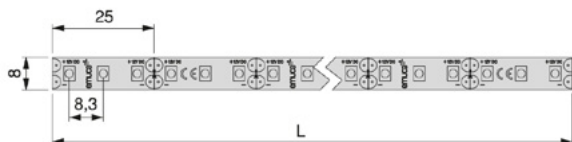

* Цената се однесува на должен метар

90924 Ладно бела, 6.000 K 362 ден.
90998 Топло бела, 3.000 K 377 ден.

LYNX Premium 14,4W/m IP20

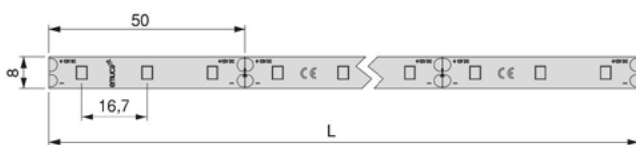
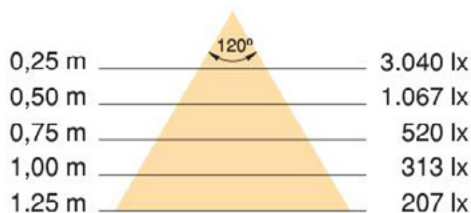

92291	Топло бела, 3.000K	535 ден./m
92292	Природна бела, 4.000K	560 ден./m
92293	Ладно бела, 6.000K	534 ден./m

LYNX Q конектор - кабел 8mm

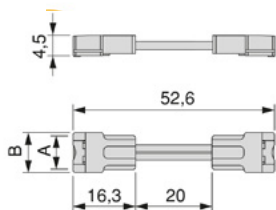
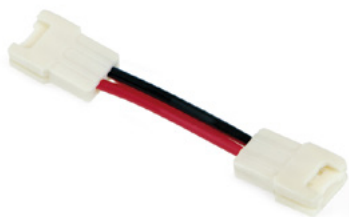

90690 | 188 ден.

LYNX H приклучен кабел

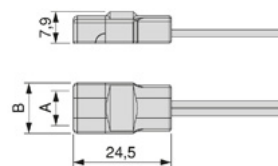

A	8
B	12,7

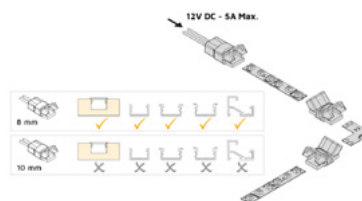

90771 | 236 ден.

ROLFLEX L-конектор 0.2W

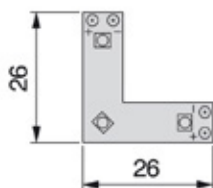
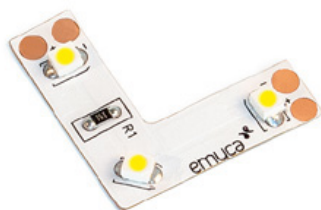

ROLFLEX 8mm конектор

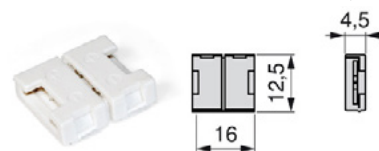

90054 | 74 ден.

- Со вграден сензор за детектирање на движења
- Време на исклучување 1 минута и 20 секунди по престан на движењата
- Влагоотпорност IP20

Шифра	Финиш	Цена
90057	Ладно бела, 7.000 K	98 ден.
90056	Топло бела, 3.500 K	98 ден.



emuca 



LYNX W Вградлив профил

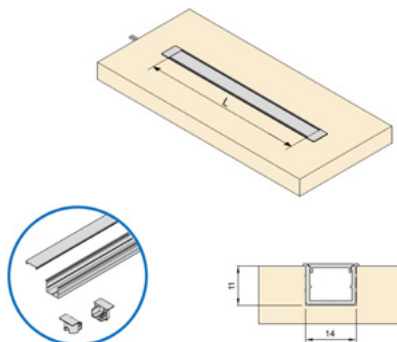
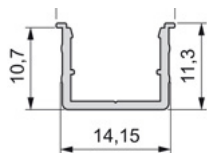
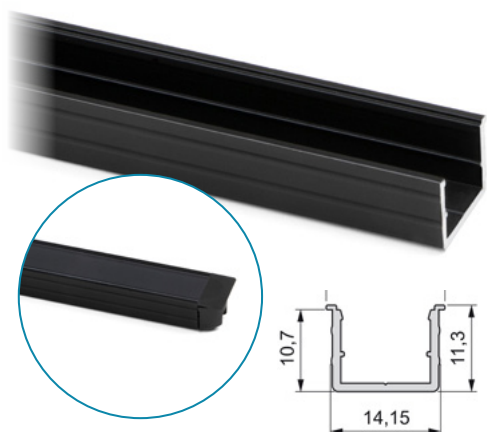

Шифра	Финиш	L	Цена
92284	Црн	2.35m	930 ден./ком.



LYNX W Надграден профил

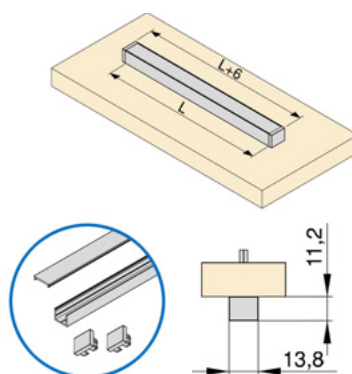
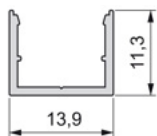
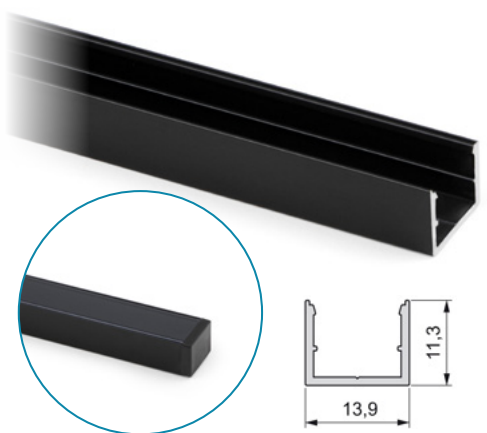

LYNX

Сет капачиња за надграден профил

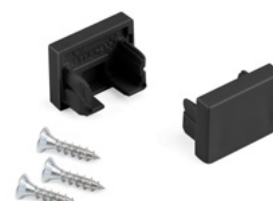

92285 | Црн | 236 ден.

Шифра	Финиш	L	Цена
92750	Елоксиран мат	2.35m	728 ден./ком.
92286	Црн	2.35m	909 ден./ком.

LYNX W Маска за надграден профил

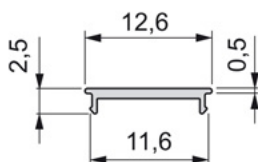

Шифра	Финиш	L	Цена
92283	Црн	2.35m	793 ден./ком.

LYNX Надграден профил

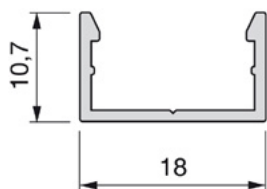

LYNX Маска за надграден профил

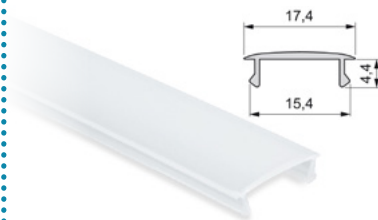

Шифра	Финиш	L/m	Цена
90014	Бел	2.35	658 ден./ком.
91776	Бел	2.9	783 ден./ком.

Шифра	L	Цена
92399	2.35 m	718 ден./ком.

LYNX Вградлив профил за LED

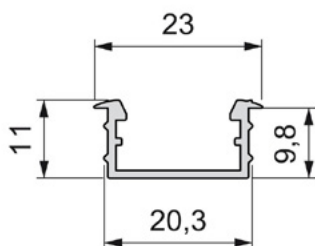
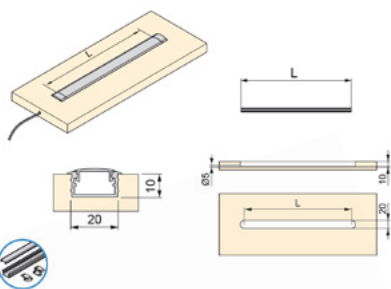

Шифра	Финиш	L	Цена
91775	Елоксиран Мат	2.9m	1.057 ден./ком.
90012	Елоксиран Мат	2.35m	732 ден./ком.

LYNX Аголен надграден профил за LED

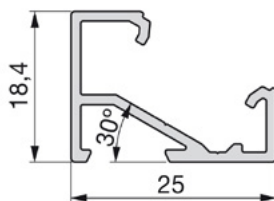

Шифра	Финиш	L	Цена
91689	Елоксиран Мат	2.35m	897 ден./ком.
92754	Елоксиран Мат	2.9m	1.242 ден./ком.

LYNX Сет капачиња за надграден профил

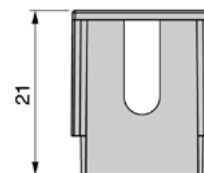
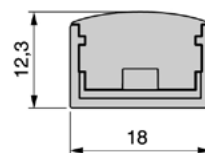
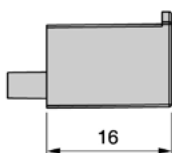
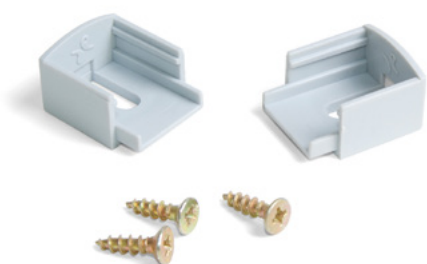

Шифра

90015

Финиш

Сив

Цена

202 ден.

LYNX Сет капачиња за вградлив профил за LED

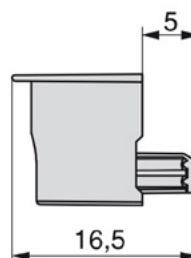
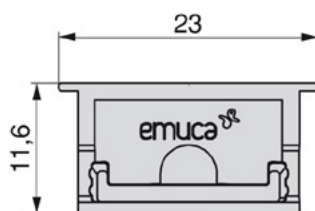

Шифра

90018

Финиш

Сив

Цена

105 ден.

92398

Црн

96 ден.

LYNX Сет капачиња за аголен надграден профил за LED

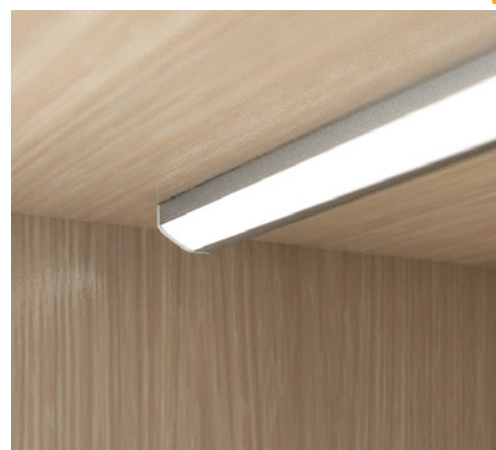
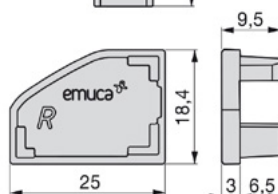
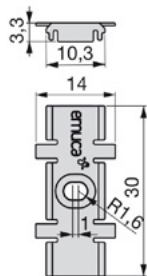
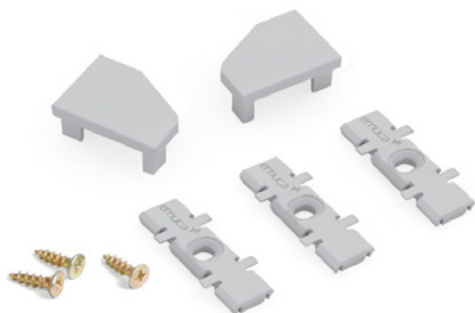

Шифра

90746

Финиш

Сив

Цена

259 ден.



ROLFLEX

90053

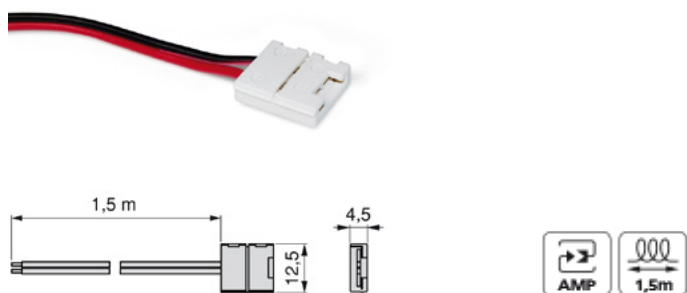

90054

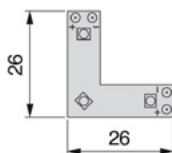
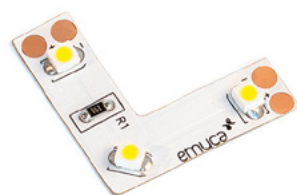

90057 | Ладно бела , 7,000 K

90056 | Топло бела , 3,500 K



LYNX Switch/dimmer сензор - 30W

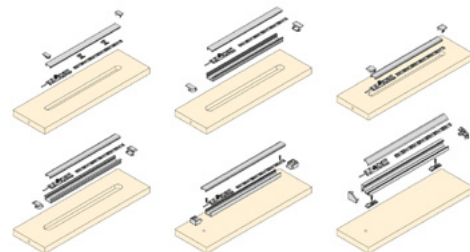
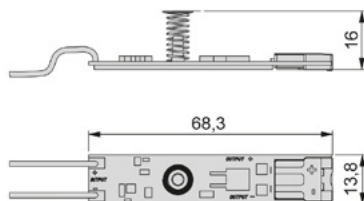
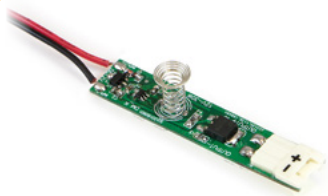
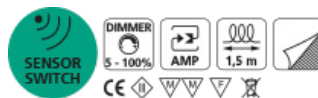

Шифра Цена
90750 | **1.130** ден.

LYNX Motion сензор за движење

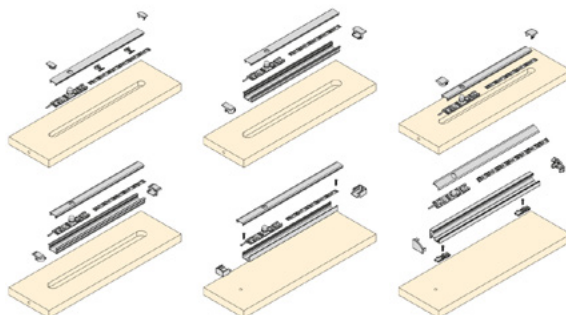
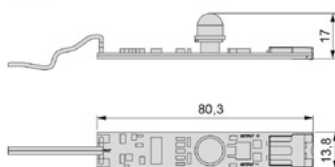

- Сензор кој ги активира лед светилките при детектирање на движења

Шифра Цена
90847 | **1.638** ден.

Spirit switch/dimmer сензор - 80W

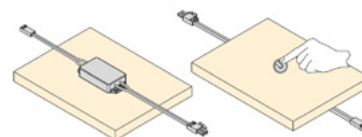
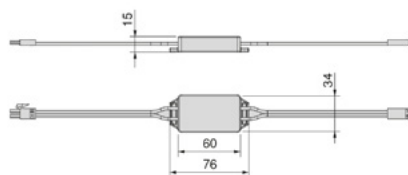

• ≤ 32 mm Wood / Legno / Madeira / Boks / Madetka / Drewno
 • ≤ 22 mm Plastic / Пластик / Тресторичка / Шпалва / Пластик / Plastikový
 • ≤ 20 mm Stone / Plocha / Piedra / Pierre / Páda / Kamen
 • ≤ 12 mm Glass / Vetro / Vidrio / Verre / Vidro / Szkło

Шифра Цена
91049 | **1.588** ден.



HERCULES огледало за бања со фронтален лед

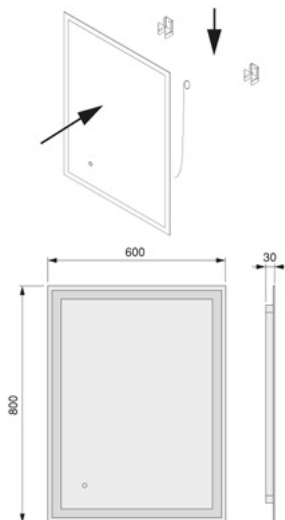

- ▶ Квадратно огледало за бања со предно ЛЕД светло (4000К).
- ▶ Систем против замаглување: отпорно на влажност и капки од вода.
- ▶ Висина: 800mm
- ▶ Ширина: 600mm
- ▶ Дебелина на огледало: 4mm
- ▶ Лесна монтажа

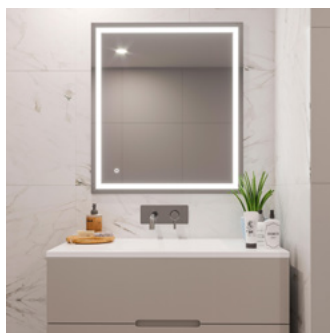

Шифра	Цена
92534	15.627 ден.

CASSIOPEIA огледало за бања со лед

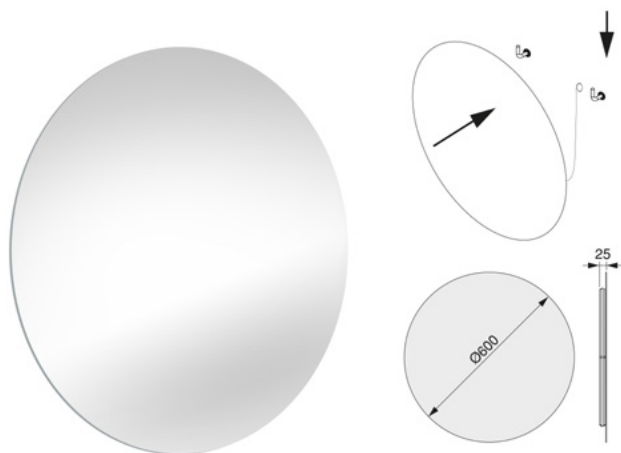

- ▶ Кружно огледало за бања со задно ЛЕД светло (4000К).
- ▶ Систем против замаглување: отпорно на влажност и капки од вода.
- ▶ Димензија: Ø600mm
- ▶ Дебелина на огледало: 4mm
- ▶ Лесна монтажа



Шифра Цена

92538 | 13.775 ден.



L
90014 | 2m
90013 | 4m

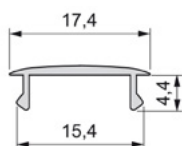

L
90012 | 2m
90011 | 4m

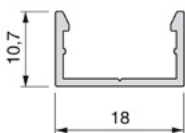

Финиш
90015 | Сива

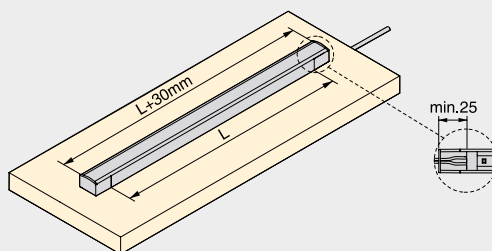
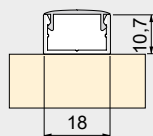
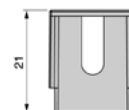
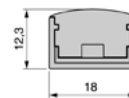
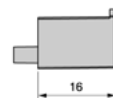

DIY





SPOT LED тело 0,3W

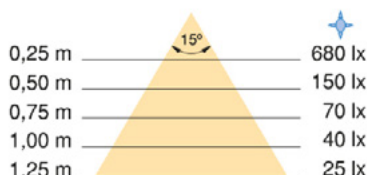
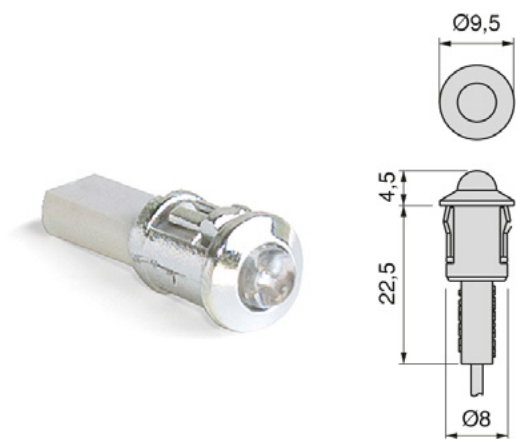

- Спот
- Вградлива лед светилка
- Мала сидна светилка за насочено ограничено осветлување.
- Наменета е за осветлување на површините на мебелот
- 6000K, ладно бела светлина

12V DC	6 W	7080920	SWITCH	7001520	DIMMER	5053125		
	15 W	7001420		DOOR		7001720	SWITCH	5007125
	30 W	7001320		MOTION		7001820	MOTION	5007025
	50 W	5008420		METAL		7001920		
	72 W	5008520						

90038 | 251 ден.



HIDRA LED тело 2W

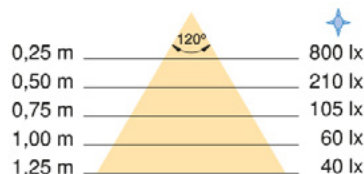
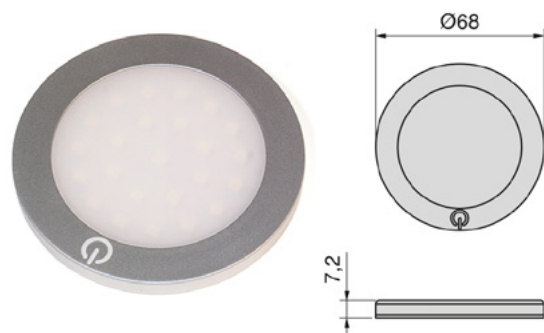

- Надградна лед светилка
- Тенка и кружна форма
- Со палење и гасење на допир
- Достапна во сива металик и мат алуминум
- Со дифузер за хомогено осветлување
- 6000K, ладно бела светлина

12V DC	6 W	7080920	SENSOR SWITCH
	15 W	7001420	
	30 W	7001320	
	50 W	5008420	
	72 W	5008520	

90040 | 1.285 ден.



POLARIS LED тело 1,2W

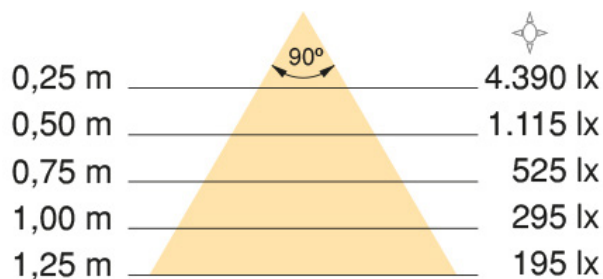
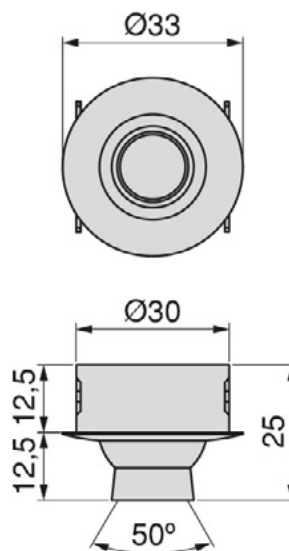

- Поларис е совршена за дискретно осветлување.
- Со вградливо тело со отвор Ø30mm
- Изработена е од алуминиум со елоксиран мат сребрен финиш
- Може а се насочува во различни правци
- 4000K, природно бела светлина



90039 | 1.227 ден.

ANDROMET LED тело 6W

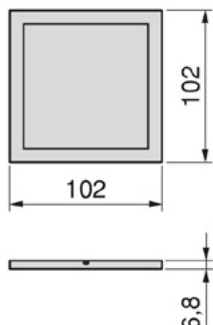

- Лед светилка со тенка квадратна форма
- Со челична рамка со никел сатин финиш
- Со дифузер за хомогено осветлување кој лед точките ги праи незабележливи
- 6000K, ладно бела светлина

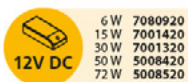

90048 | 2.109 ден.

ANDROWAVE SWITCH LED тело

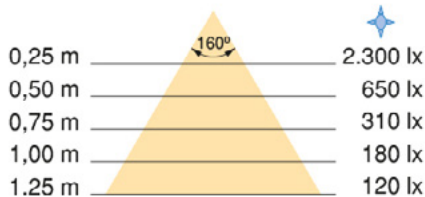
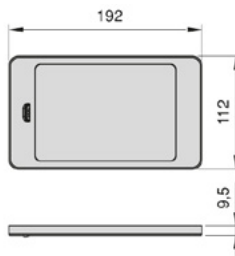
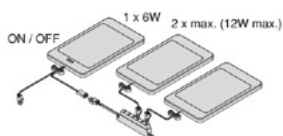

- Лед светилка за монтажа под висечки елементи во кујна, и за внатрешност на гардеробери
- Со сив металик финиш
- Со дифузер за хомогено осветлување кој ги прави лед точките незабележителни
- 180 лумени
- Со 9 лед точки
- Ладно бело

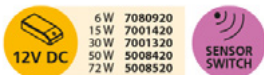

90044 | 3.651 ден.

ANDROWAVE ЛЕД тело 6W

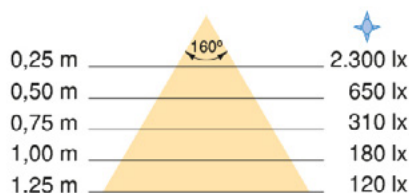
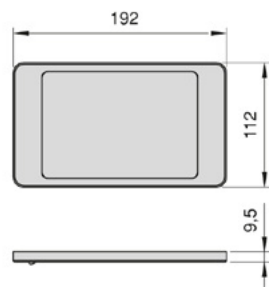

- Мала ѕидна светилка за насочено ограничено осветлување.
- Наменета е за осветлување на површините на мебелот
- 6000K, ладно бела светлина



90043 | 2.536 ден.





URANE ЛЕД тело 1.8W

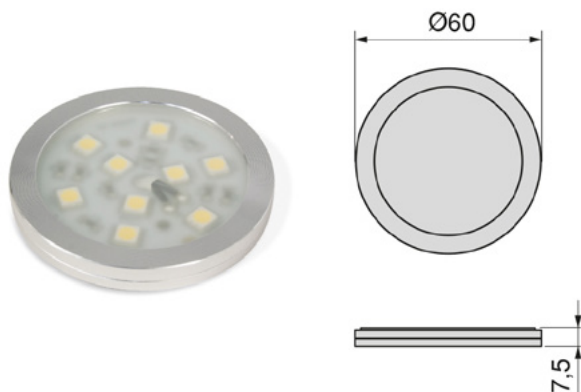

	110°	★	☆
0,25 m	1.200 lx	900 lx	
0,50 m	330 lx	230 lx	
0,75 m	156 lx	110 lx	
1,00 m	90 lx	65 lx	
1,25 m	60 lx	45 lx	

12V DC	6W 7080920	SENSOR 240V AC	SWITCH 7001520	SENSOR 12V DC	DIMMER 5053125
	15W 7001420		DOOR 7001720		SWITCH 5007125
	30W 7001320		MOTION 7001820		MOTION 5007025
	50W 5008420		METAL 7001920		
72W 5008520					

- Надградна лед светилка со 9 лед точки во алуминумска рамка со кружна форма
- Со дифузер за хомогено осветлување
- Многу лесна монтажа на површината на елементи од мебел со лепенка

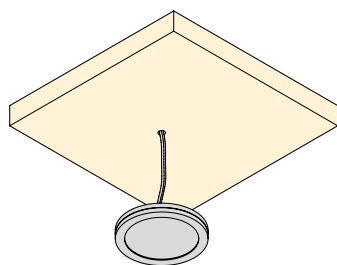

90042 | 1.035 ден.



CRUX ЛЕД тело 1.8W

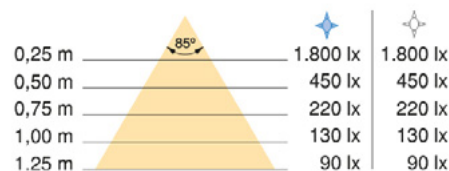
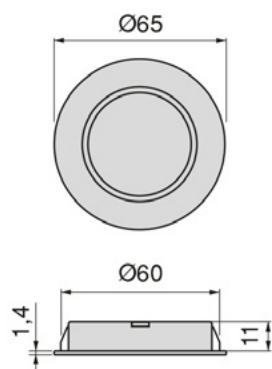
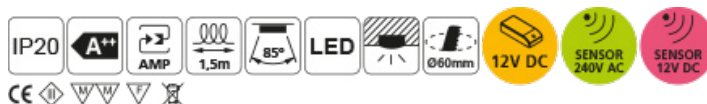

- Отвор за вградување Ø60mm
- Има диоди кои се така подредени да дадат концентрирана светлина под агол од 85°
- 6000K, ладно бела светлина / 4500K, природно бела светлина

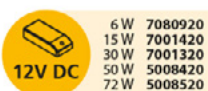

- | | | | | | | |
|-------|--|---------------|--|---------|--|----------|
| 90030 | | ладно бела | | Сребрен | | 639 ден. |
| 90031 | | ладно бела | | Никел | | 852 ден. |
| 90032 | | природно бела | | Сребрен | | 639 ден. |

CRUX држач за ЛЕД тело

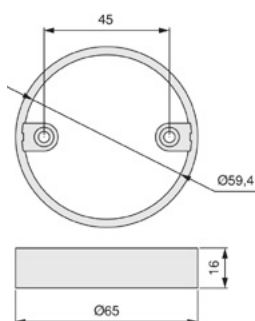

- | | | | | |
|-------|--|---------|--|----------|
| 90036 | | Сребрен | | 96 ден. |
| 90035 | | Никел | | 128 ден. |

CRUX триаголен држач за ЛЕД тело

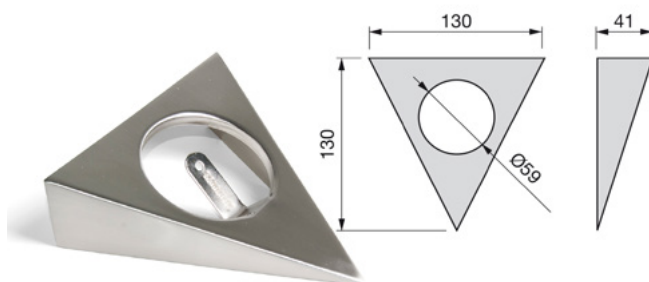

- | | | |
|-------|--|----------|
| 90037 | | 403 ден. |
|-------|--|----------|







PIX Светличка оклагија



90045	706 mm	1,5W	4.986 ден.
90046	856mm	1,9W	5.445 ден.
90047	1006mm	2,2W	5.849 ден.

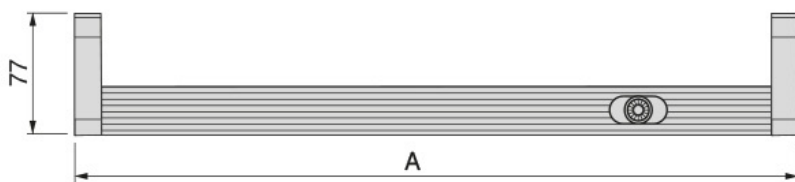
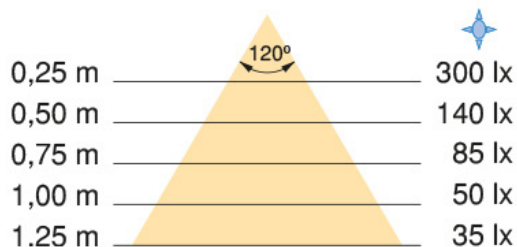

$L = A - 7 \text{ mm}$

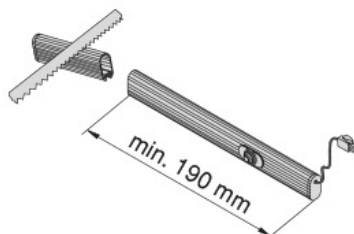
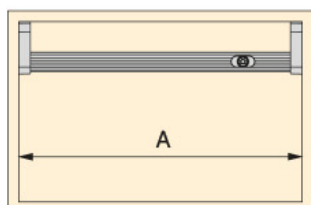

DIFLEX ЛЕД тело

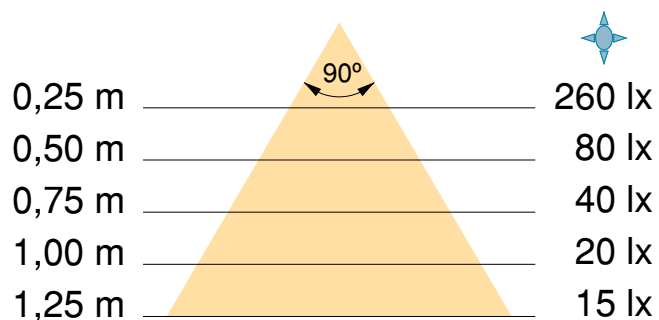
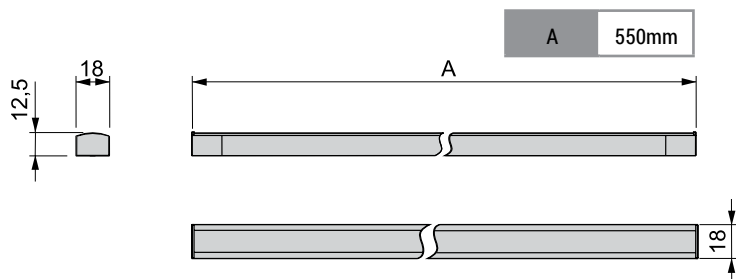
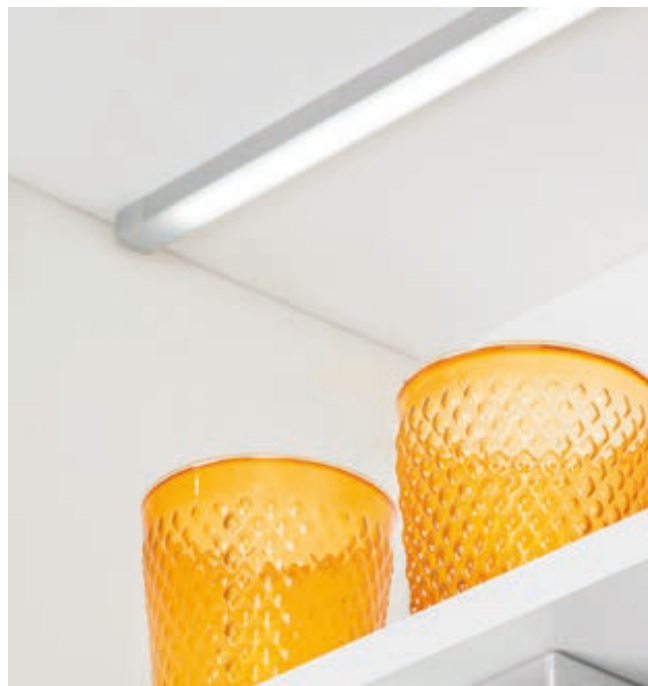

91143 | 4,3W; 6000K ладно бело | 2.028 ден.





ЛЕД тело за фиока 0,6W



90159 | 0,6W; 28lm; 4LEDs | **1.133 ден.**

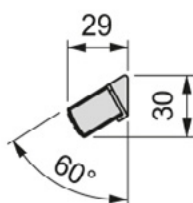
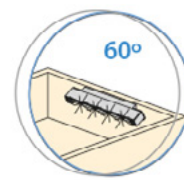
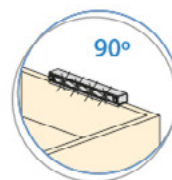
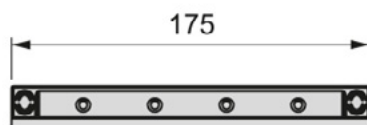
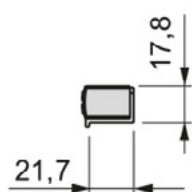
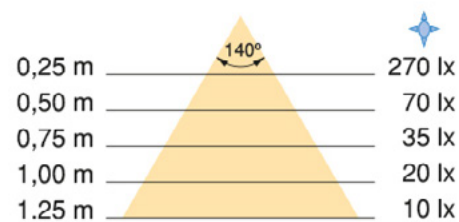
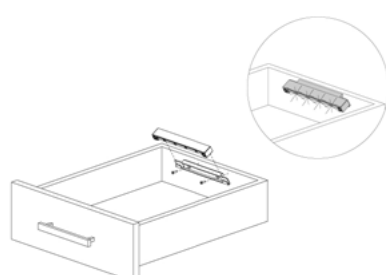
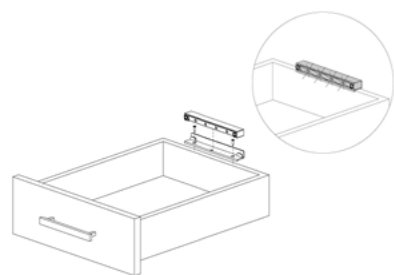





ЛЕД конвертор



• Конвертор за Лед светла со постојан напон, дизајниран за поврзување на кабли со различни приклучоци.

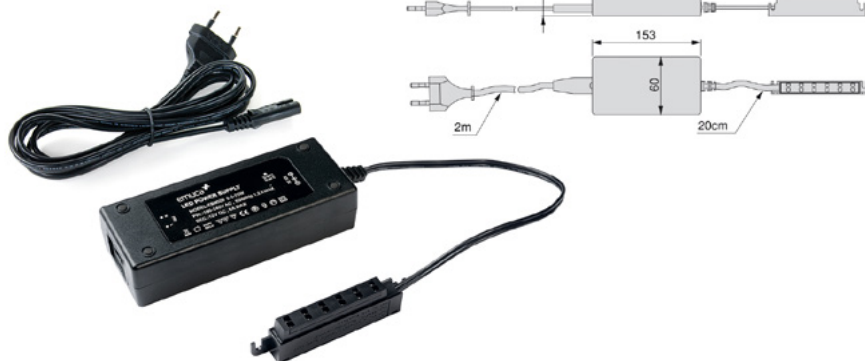

Шифра	Опис	Цена
90033	6W 12V	699 ден.
90034	15W 12V	875 ден.
90041	30W 12V	1.595 ден.
90052	50W 12V	2.875 ден.
90848	72W 12V	3.295 ден.

ЛЕД конвертор 12V

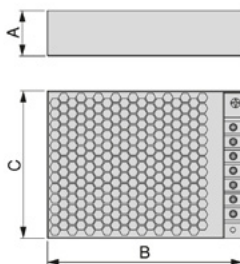

Шифра	Сила	A/mm	B/mm	C/mm	Опис
91831	100W	30	129	97	4.113 ден.
92154	200W	30	215	115	6.463 ден.

12V AMP Раскрсница/кабел

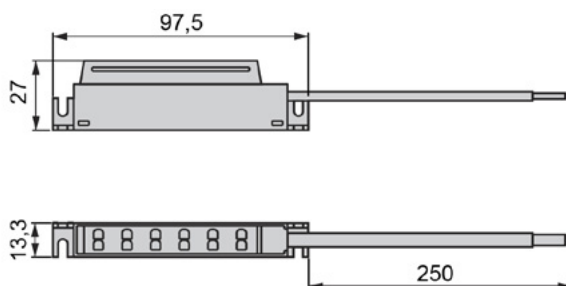
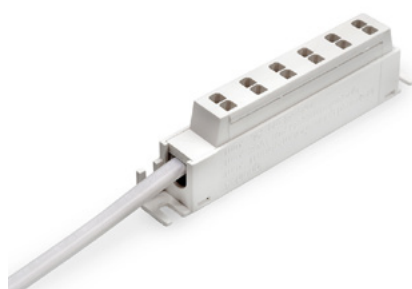

90065 | 152 ден.

12V AMP Продолжен кабел

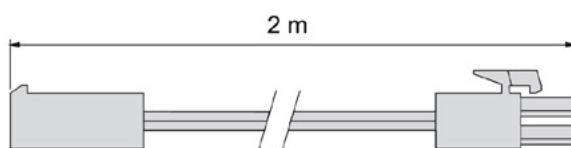
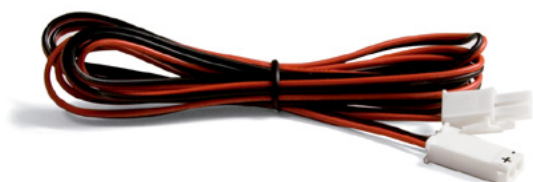

90064 | 169 ден.

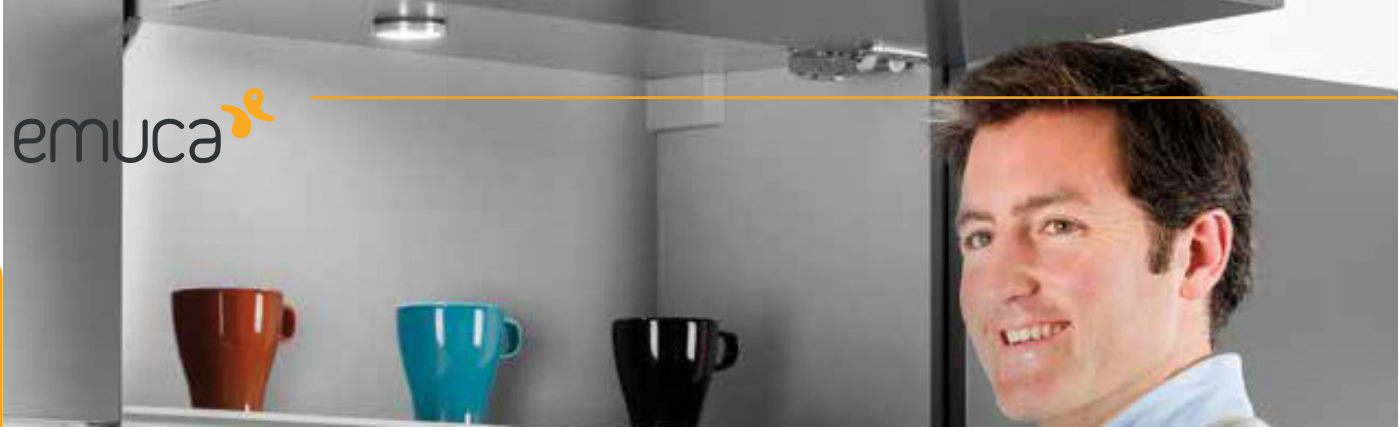

Point Door (proximity) сензор

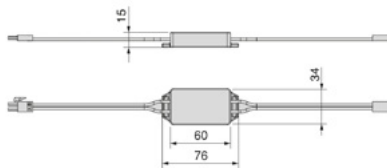
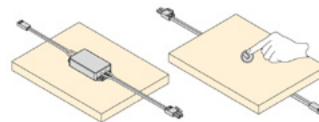

- 12V DC / 24V DC сензор
- 36W (12V DC)
- 72W (24V DC)

91115 | 1.950 ден.

Point Motion (proximity) сензор

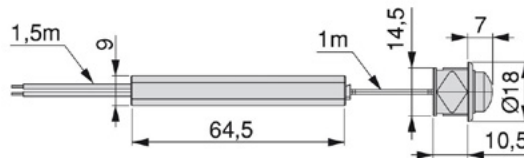
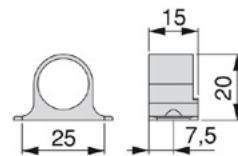

- Сензор на движење
- 36W(12V DC) - 72W(24V DC)

92557 | 1.841 ден.

Прекинувач вградлив Ø23 x 17

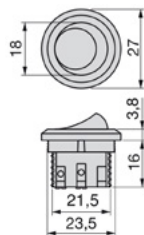

Шифра	Финиш	Цена
90059	Бел	118 ден.
90058	Црн	98 ден.

Прекинувач за врата

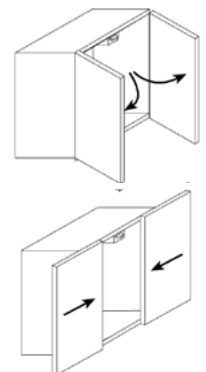
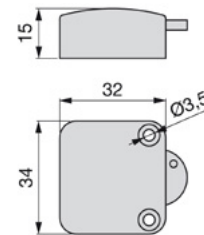

Шифра	Финиш	Цена
90061	Бел	265 ден.
90060	Црн	305 ден.

Вертикален мултиконектор 3UE + 2 USB

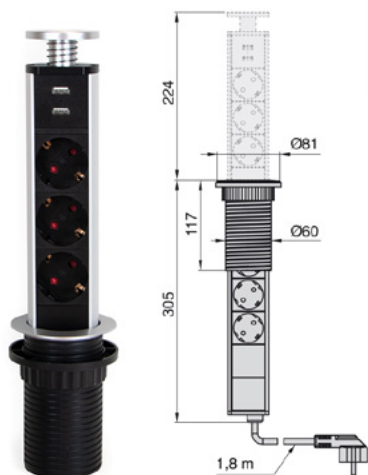

оже да се вгради и во високи и ниски елементи
годарение на неговиот дизајн. Лесно се
текува и може мануелно да се затвори односно
ле. Содржи три шуко приклучници и два USB
ектори за полнење на електронски уреди.

90063 | 3.115 ден.

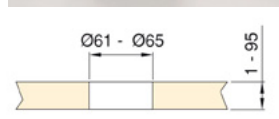

Вертикален мултиконектор 2UE + 2 USB

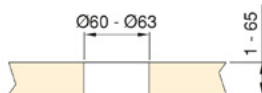
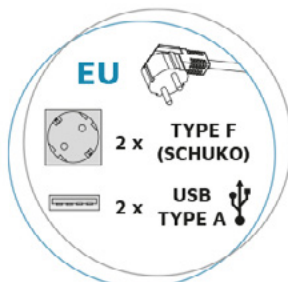

91829 | 3.576 ден.

Вертикален мултиконектор Push 100

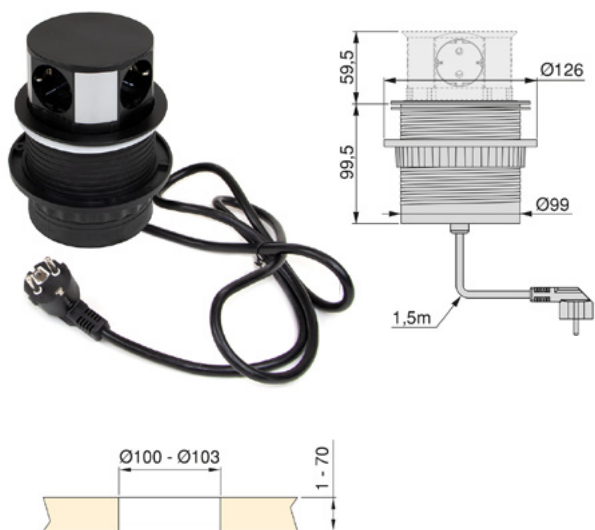

Шифра | Финиш | Цена
91837 | Црн | 3.930 ден.

Утичница со капаче Schuko + USB

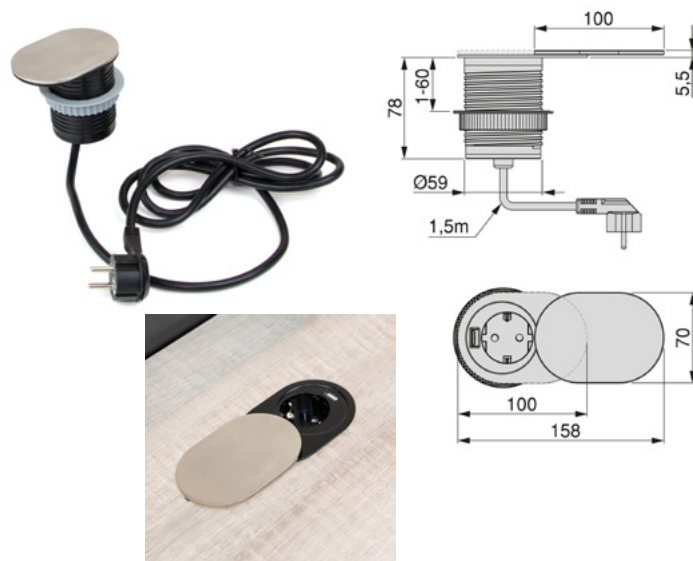

Шифра | Финиш | Цена
92074 | Инокс | 2.375 ден.



Atom 14 мултиконектор

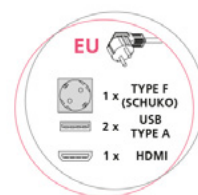
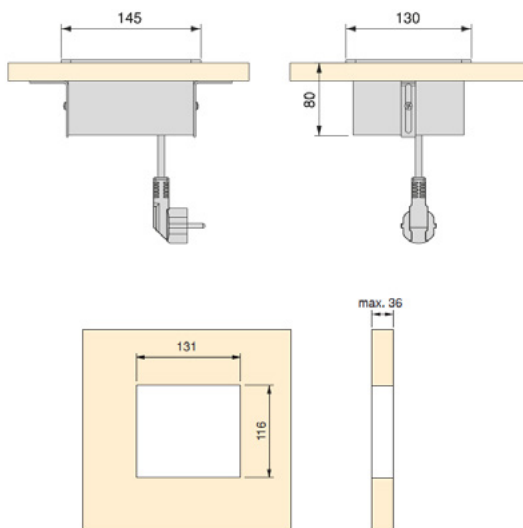

- 1x F
- 2x USB
- 1x HDMI

Шифра	Финиш	Цена
90327	Црн	4.767 ден.
90326	Сребрен	4.852 ден.



Atom 26 мултиконектор 2xUSB/1 x 1A / 2 X 0.5A/RJ45/HDMI

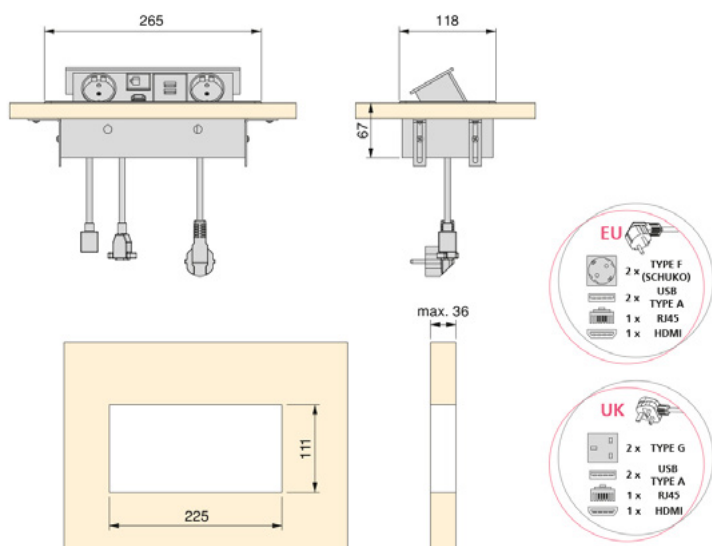

Шифра	Финиш	Цена
92073	Бел	6.172 ден.
90458	Црн	6.724 ден.



Безжичен полнач USB 5V DC/ Qi (V1.1)

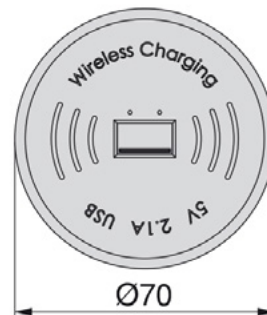
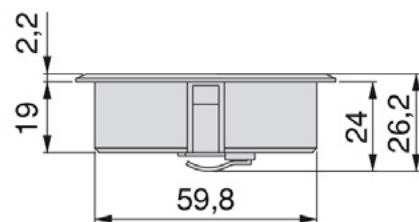

• Овозможува безжично полнење на било кој компатибилен уред

90062 | **3.216** ден.



Топлина на светлото

KELVIN

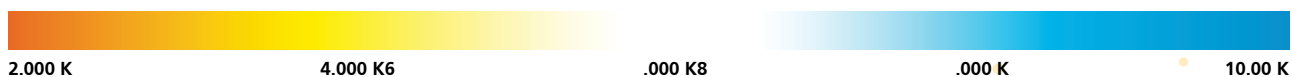

3.000 - 4.000 K

Топло
светло



5.000 - 7.000 K

Ладно
светло



6W 7080920
15W 7001420
30W 7001320
50W 5008420
72W 5008520

Користете волтажен
конвертор



6W 7083515
12W 7083515

Користете конвертор на
интензитет



~AC
220-240V
50-60Hz

Без потреба од ЛЕД
конвертори



Работи на батерии

1. Вклучените батерии се за пробна
употреба. 2. Вклучените батерии се
на полнење.